

HI, I'M MATEO STURLA

I have a deep passion for understanding the way things work. Sustainability is also a particularly interesting challenge for me and I think of design as a path to explore and find solutions.

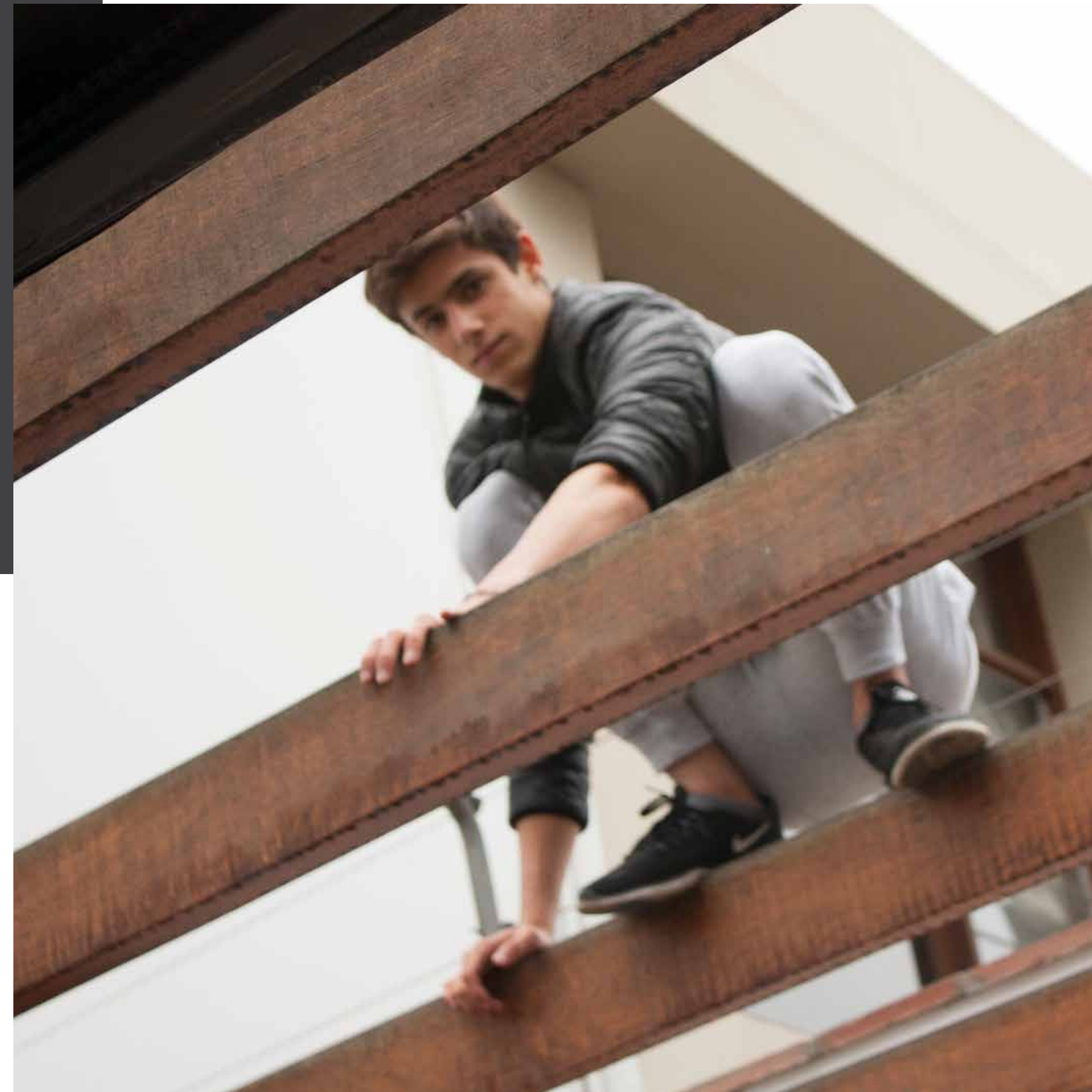

ABOUT



SURFING

**PROYECTO HOGAR
HOUSE BUILDING**



COOKING



STAND UP BODDLE (SUB)



PROJECT SUMMARY

Build your own SUB, recycle 43 bottles, and practice this amazing sport! This design is a collaboration with Alvaro Chang Say (Industrial designer). The project had as its goal to design a SUP made of plastic bottles that could be easily assembled and be as hydrodynamic as possible. We are currently looking for a sponsor to fund the plywood structure to make it accessible to low-income communities

DESIGN PROCESS

The first thing we defined was how the bottles would be assembled to the plywood structure. Then we defined the general SUP shape, selected the bottles that would be needed to achieve the shape, measured them and drew each piece of the structure in AutoCAD. Then we used a CNC to cut the plywood structure and finally assembled it all.

March-September 2019

BACKGROUND RESEARCH

CLASSIC SUPs

PROS

- Hydrodynamic
- Lightweight

CONS

- Shaping surfboards leaves a lot dust, toxic when inhaled
- Classic SUPs are made from EPS foam, a non recyclable, highly pollutant material
- Chemical resins used for coating the foam



RECYCLED SUPs

PROS

Made with recycled materials

CONS

- Don't have convex bottom (like classic SUPs)
- Still need some sort of chemical glue to connect the bottles with each other

BOTTLE ASSEMBLY MECHANISM

The mechanism we created to connect the bottles, consisted of two parts, a wooden structure and the bottles, and together took advantage of a screwing bottle cap.

The diameters of the plastic bottle necks were either 28 mm or 52 mm. Circular perforations in the wooden structure intended to allowed for the capping of the bottle to result in fastening it to the wooden structure and at the same time, keeping an airtight seal preventing water from filling it.

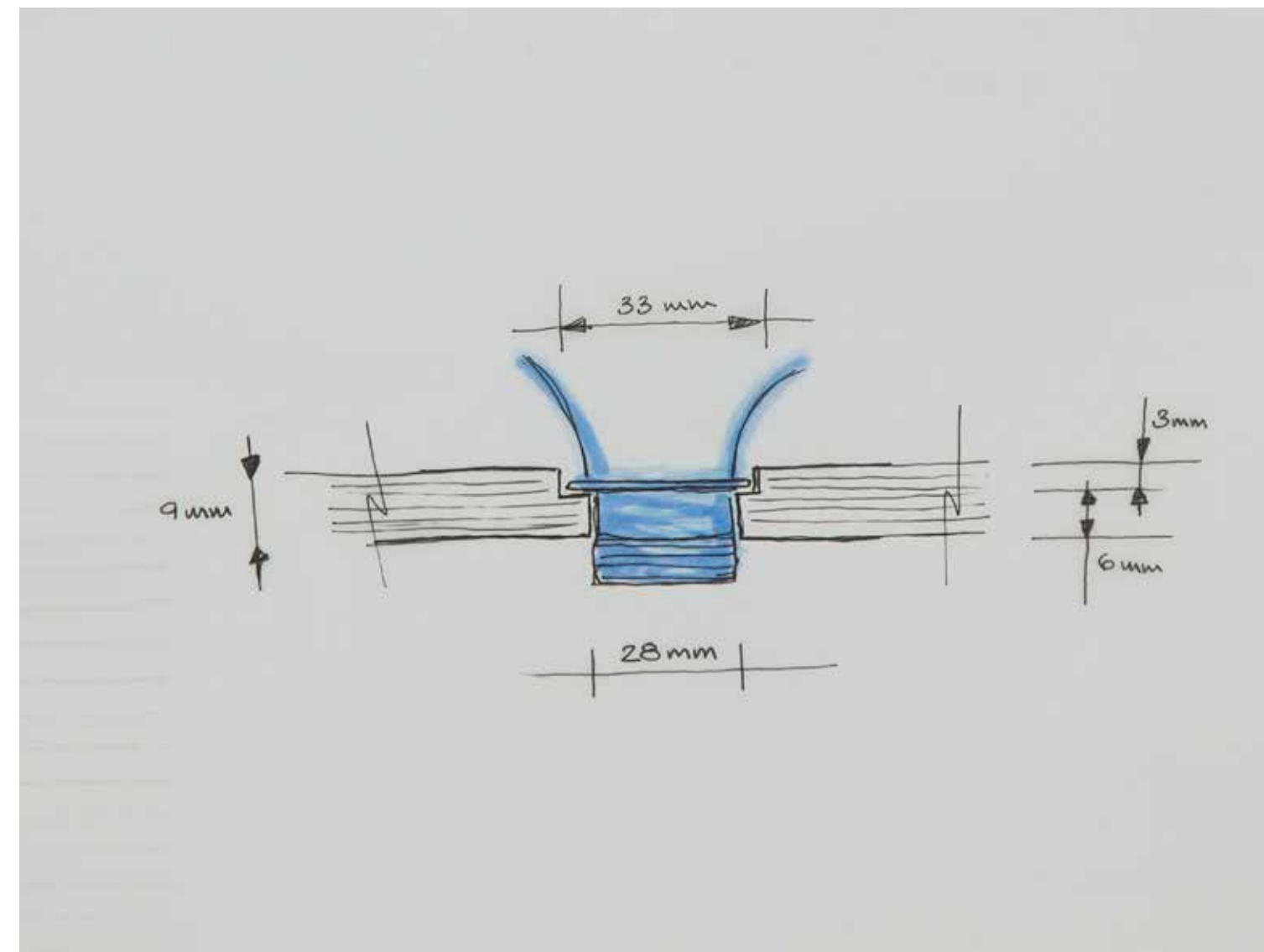
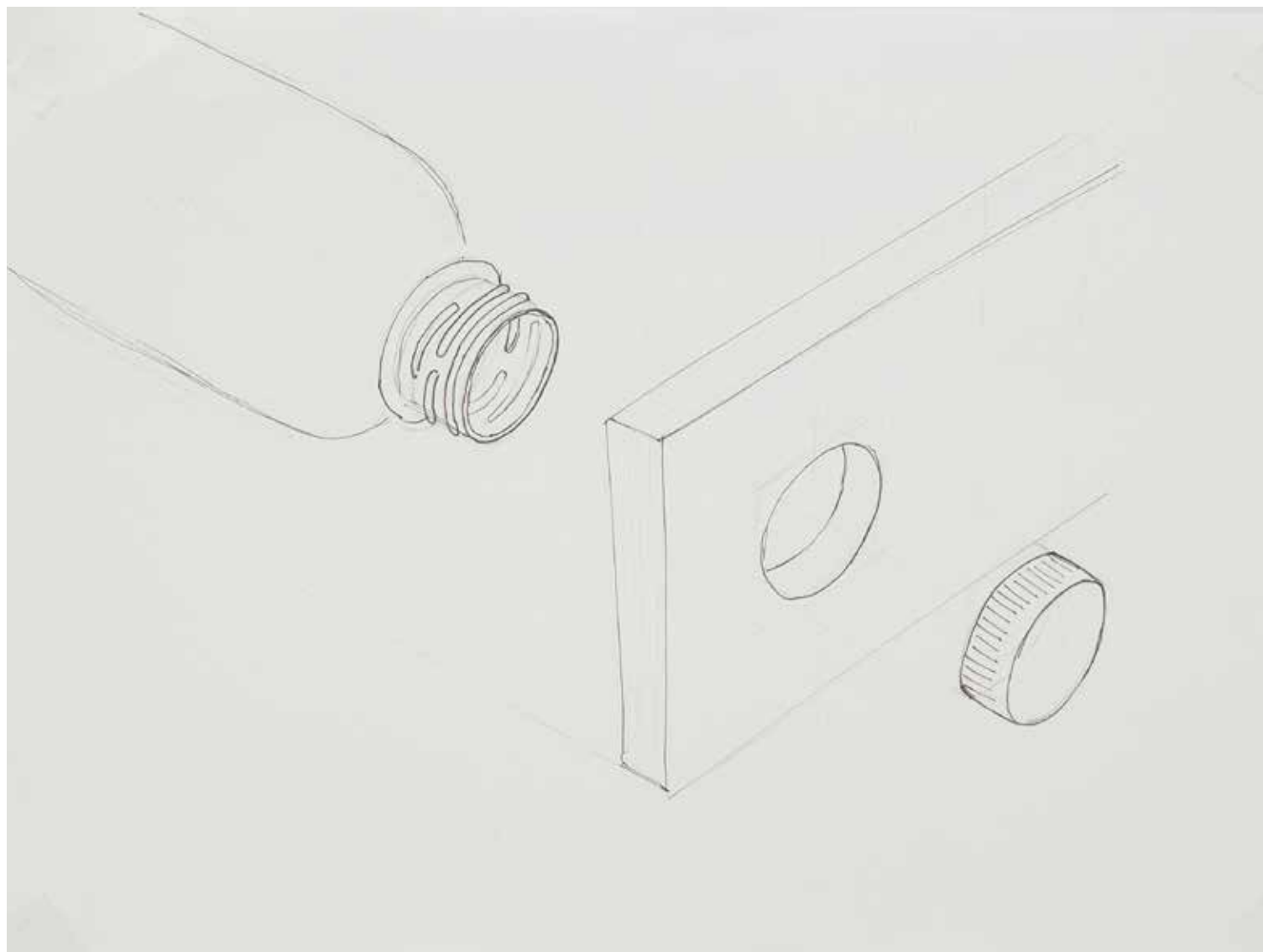

PLYWOOD STRUCTURE

We designed a cross lap joint between the plywood pieces that would make up the structure of the Stand Up Boddle.

Next, we selected the bottles that we would use, with the aim being to achieve the most hydrodynamic shape possible.

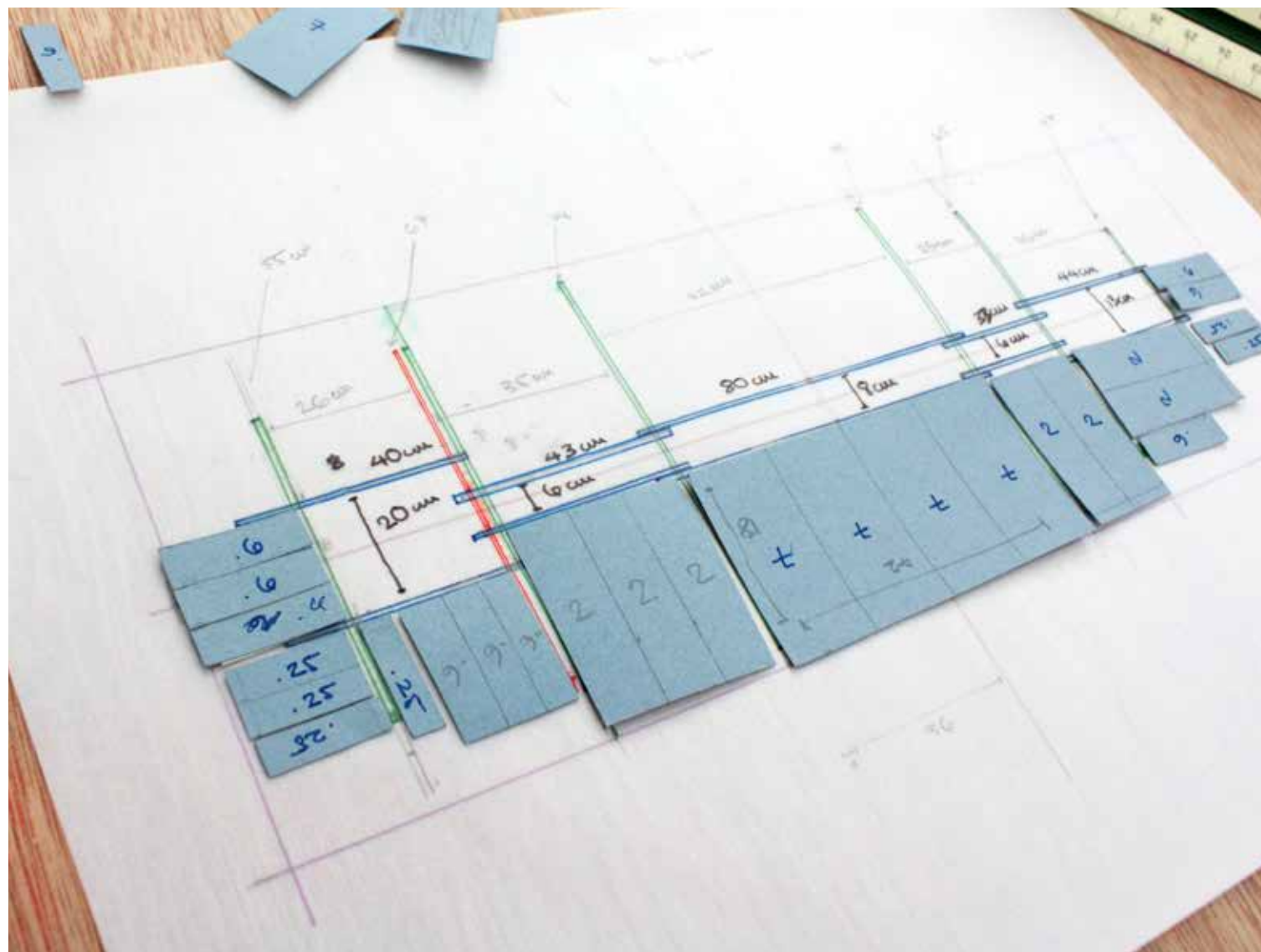
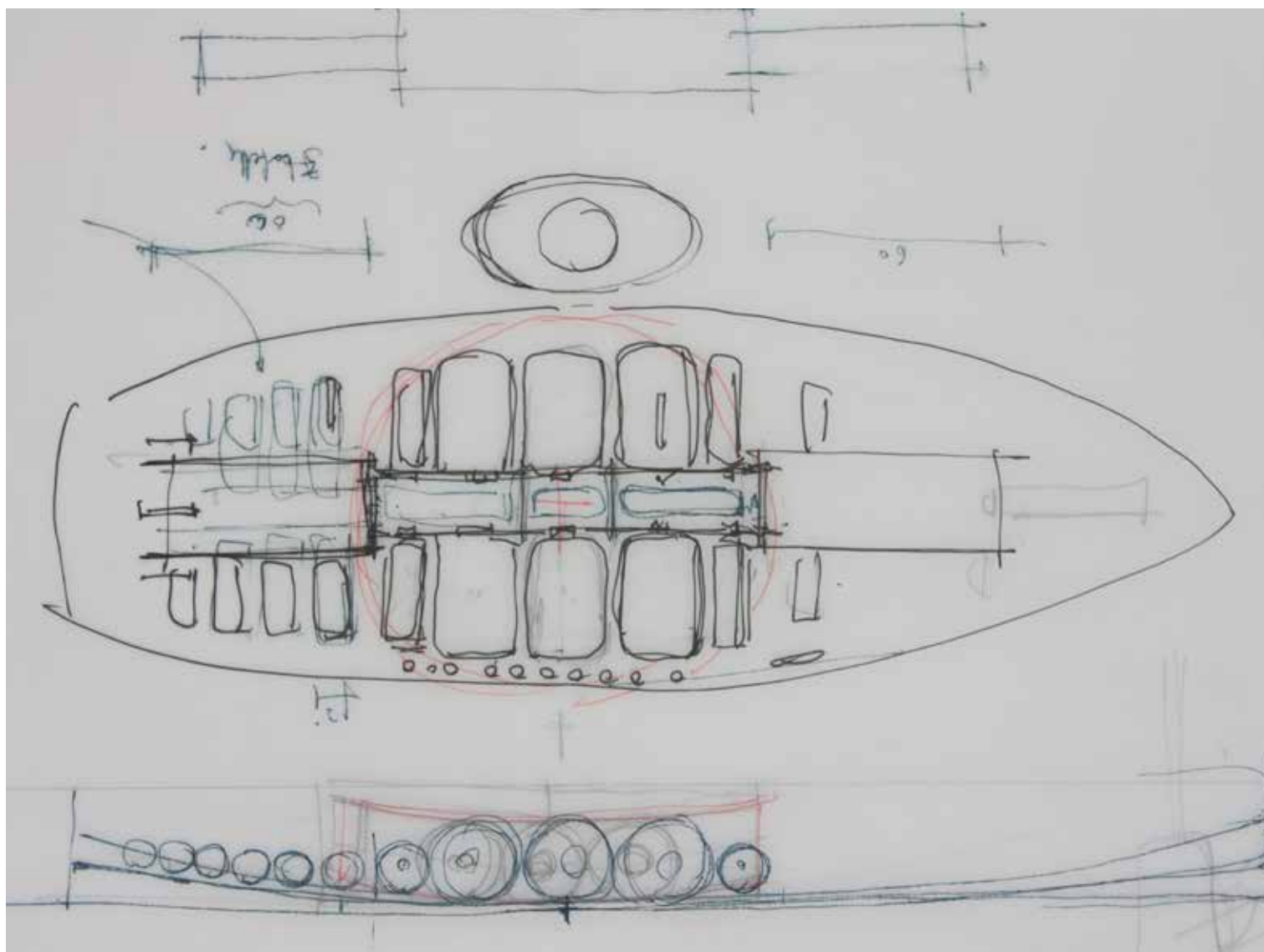
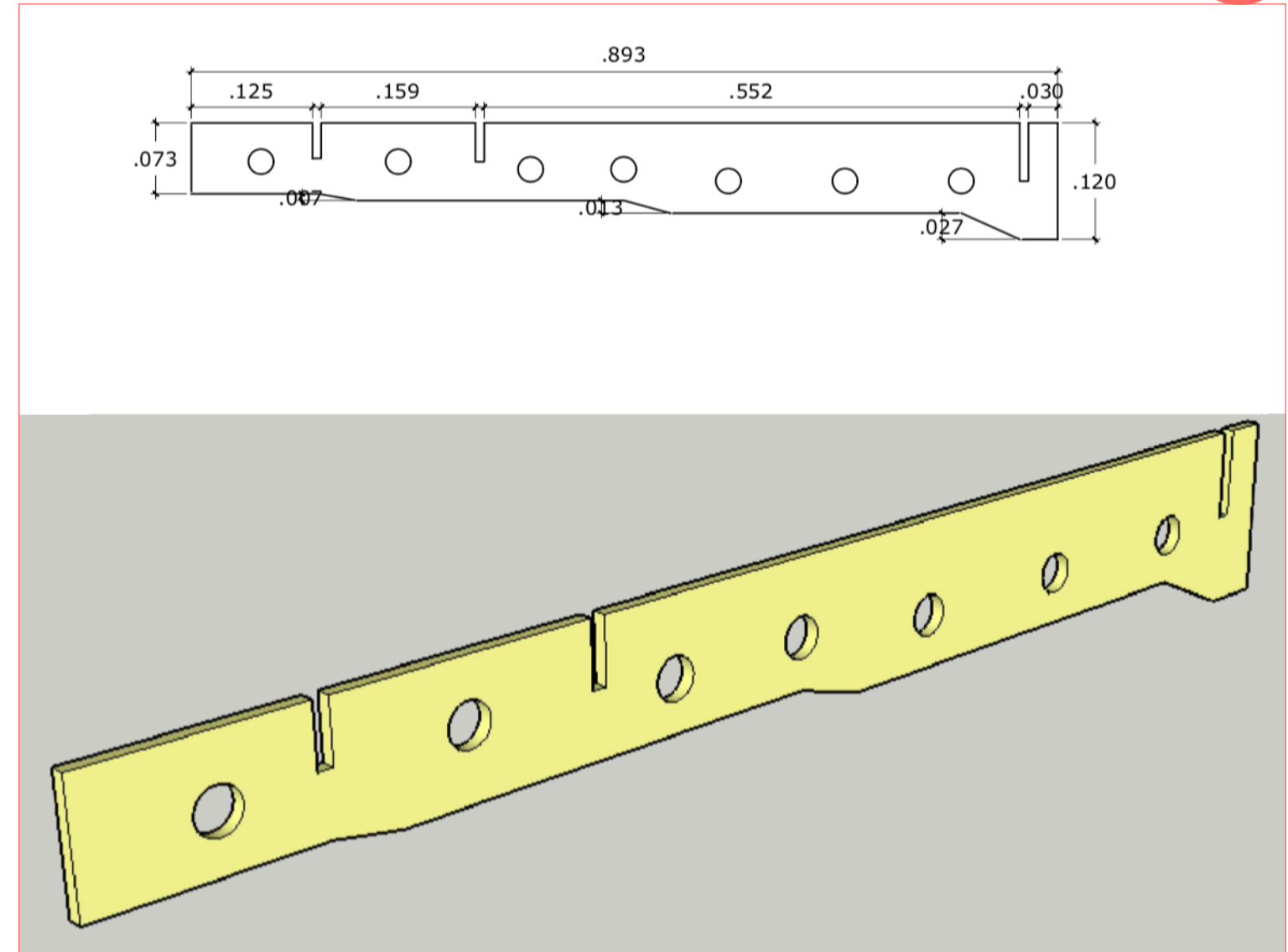

DETAILS (CLOSEUPS)

- Cross lap joints
- Assembly of the deck and the structure
- Bottles in the plywood structure
- Handle

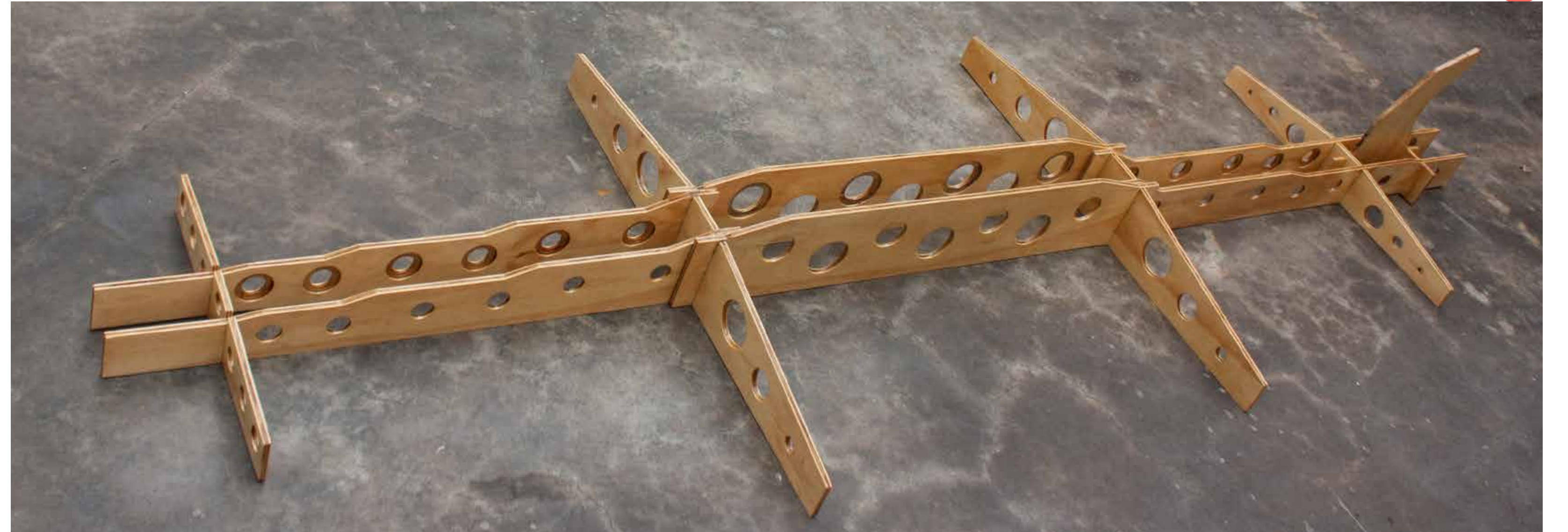

BLUEPRINTS FOR CNC CUTTING

We made the blueprints for each part in AutoCAD and then some renderings in SketchUp to better visualize how the pieces would be assembled.

Then, we cut the pieces from one and a half plywood sheets.

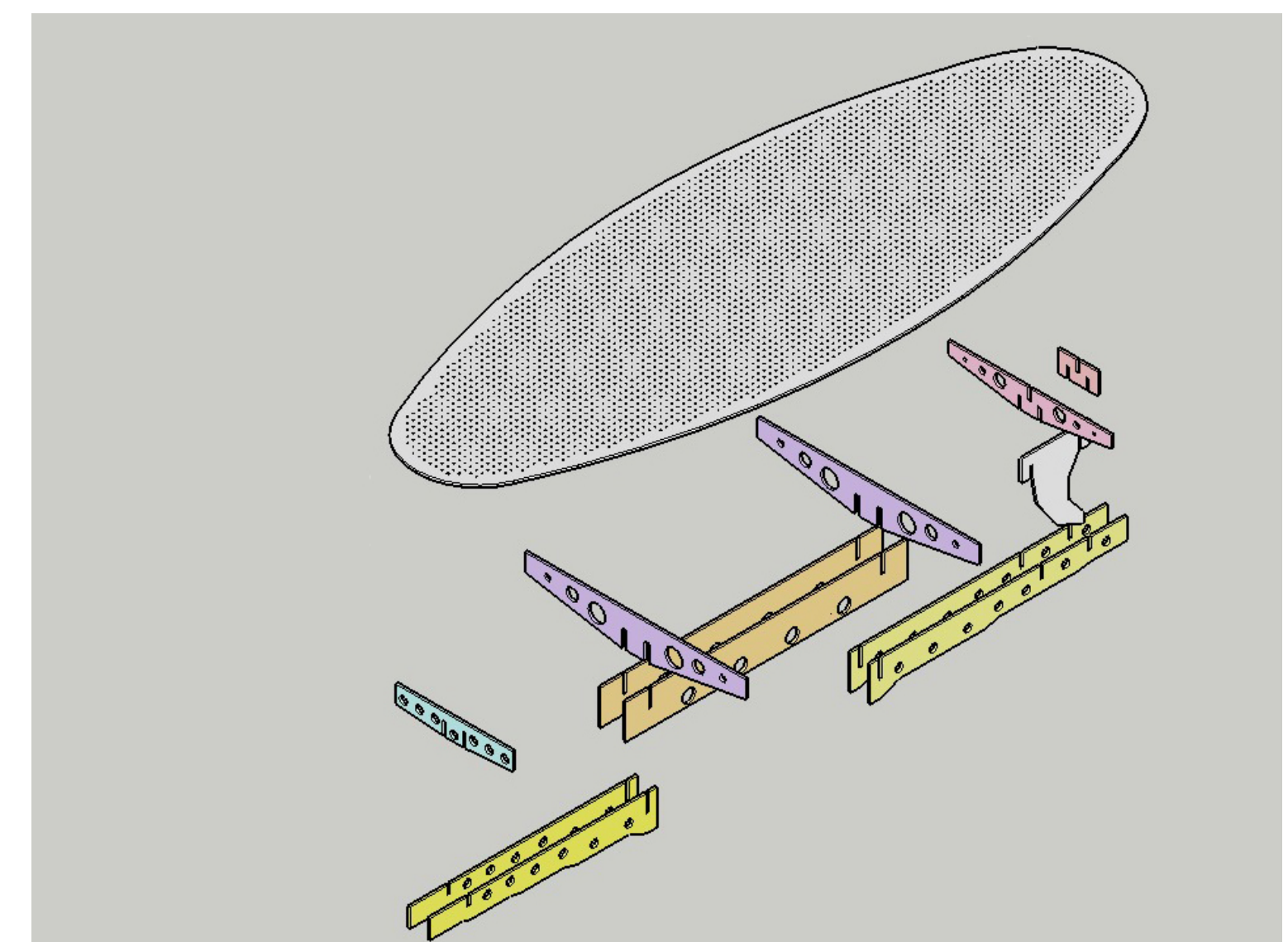
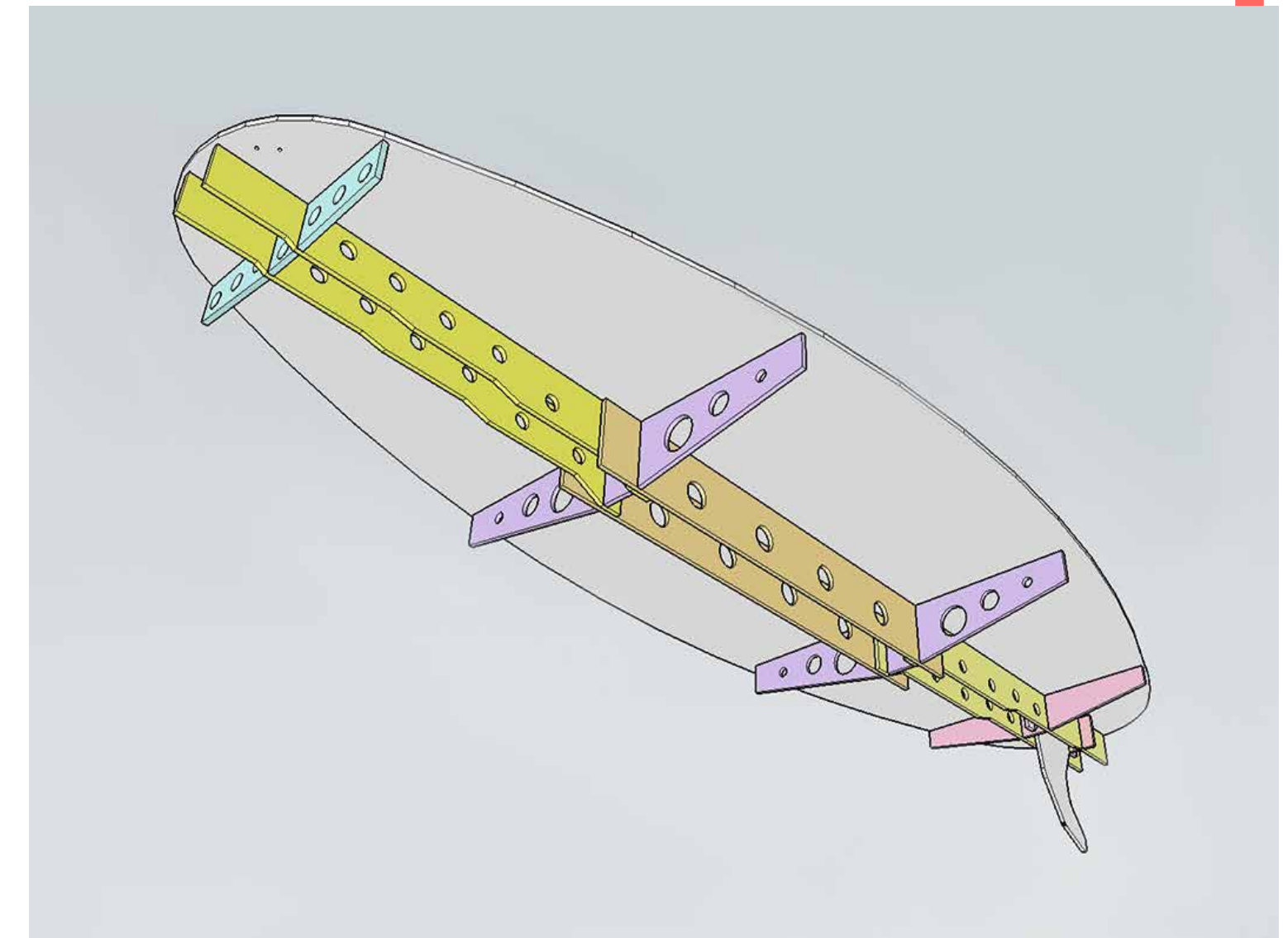

PADDLE AND FIN DESIGN

To achieve the best paddle we mimiced an already existing one

For the fin, we did the same plus we adjusted it to fit in the plywood structure with the cross lap joint.

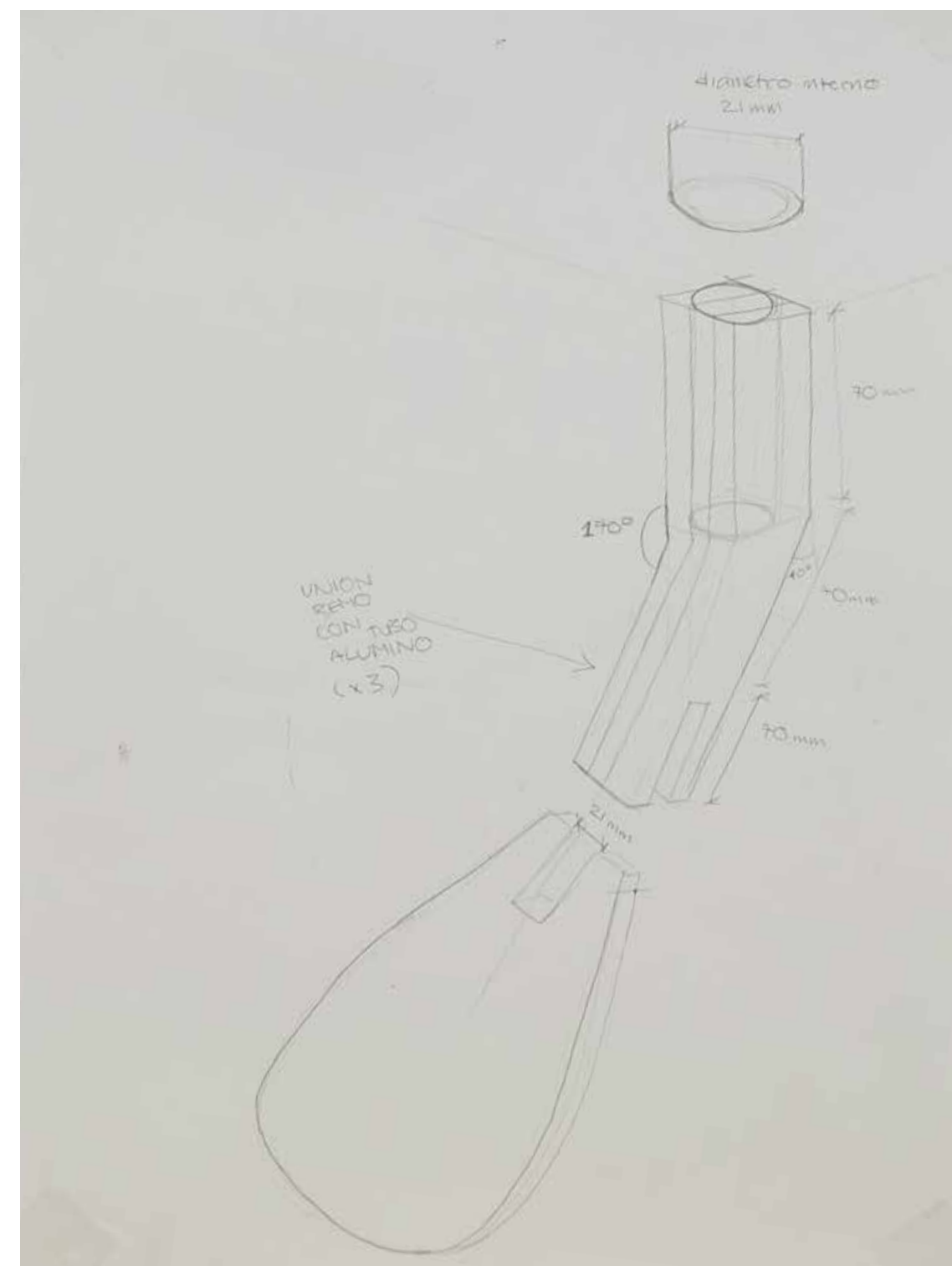



TESTING

Testing on the sea at CLub de Regatas Lima
-Floats really well
-The fin could be longer for improved direction



FINAL PRODUCT



PVC PIPE LAMP



PROJECT SUMMARY

I wanted to create a lamp that was unique. I started exploring different possibilities and found that PVC could be an interesting material to explore. Most of the PVC pipe lamps that I found didn't have movable parts, and the light direction could not be adjusted, so I set a goal to create a functional lamp with adjustable light direction made with PVC pipes.

DESIGN PROCESS

I started by researching different aspects of already existing lights to then combine them into an elegantly shaped lamp made from PVC pipes left over from a construction site.

July 2019

BACKGROUND RESEARCH



PROS

Moving mechanisms enable the adjustment of the light direction.

CONS

The mechanisms need springs and a bendable material or bolts, which get worn out over time

PROS

The lamp is made from PVC pipes that can be recycled

CONS

Light direction cannot be adjusted

BRAINSTORMING

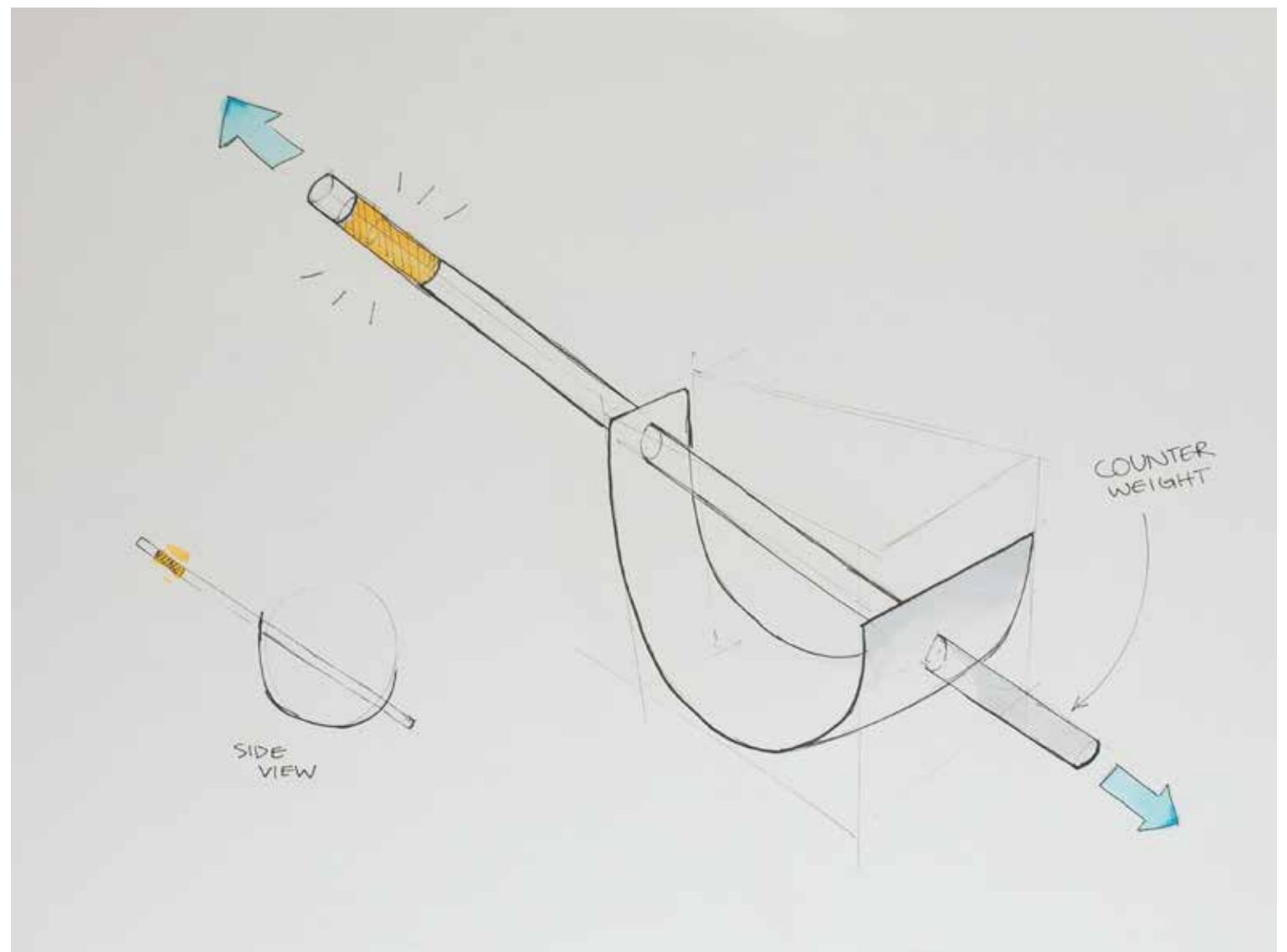
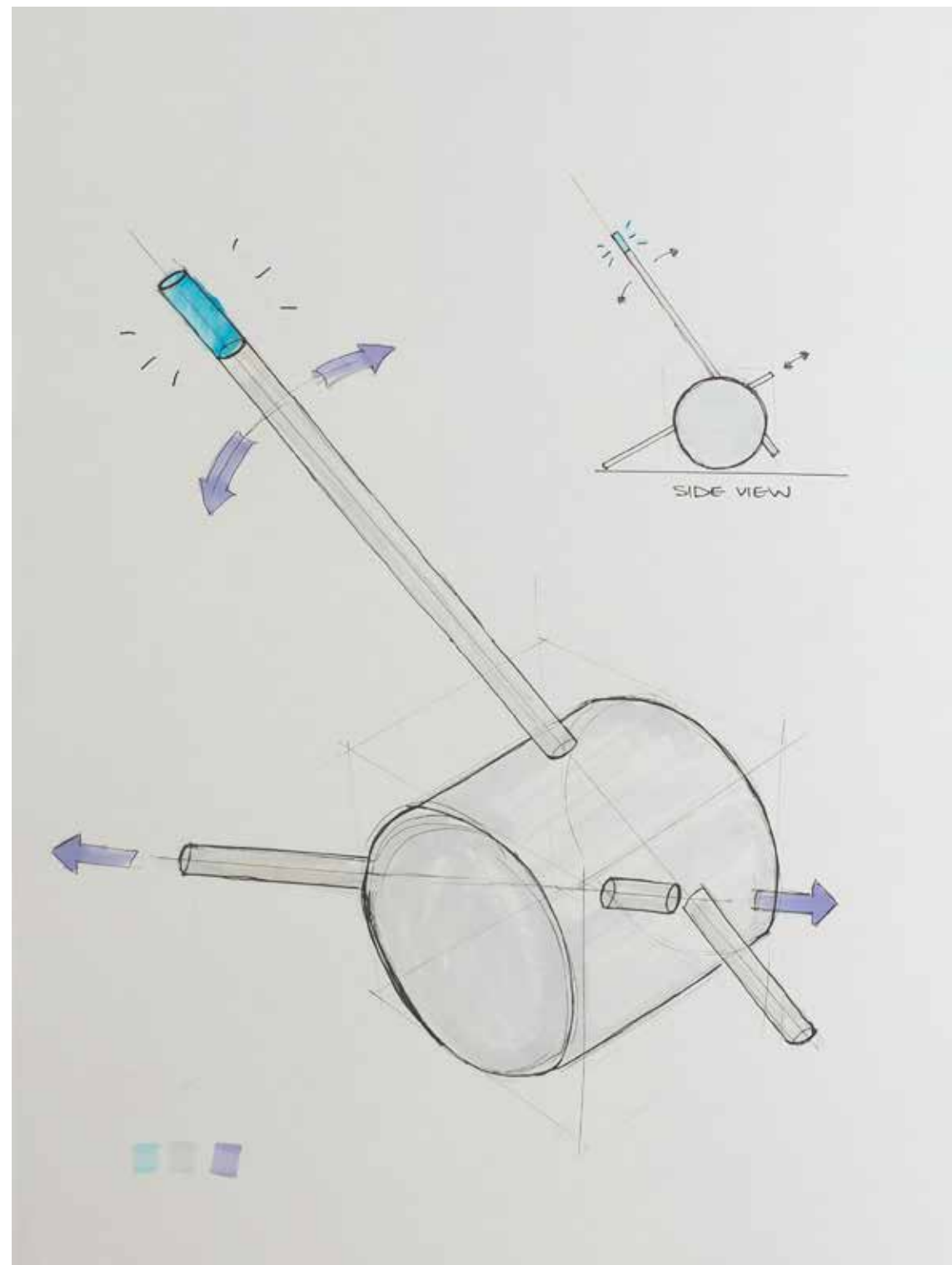
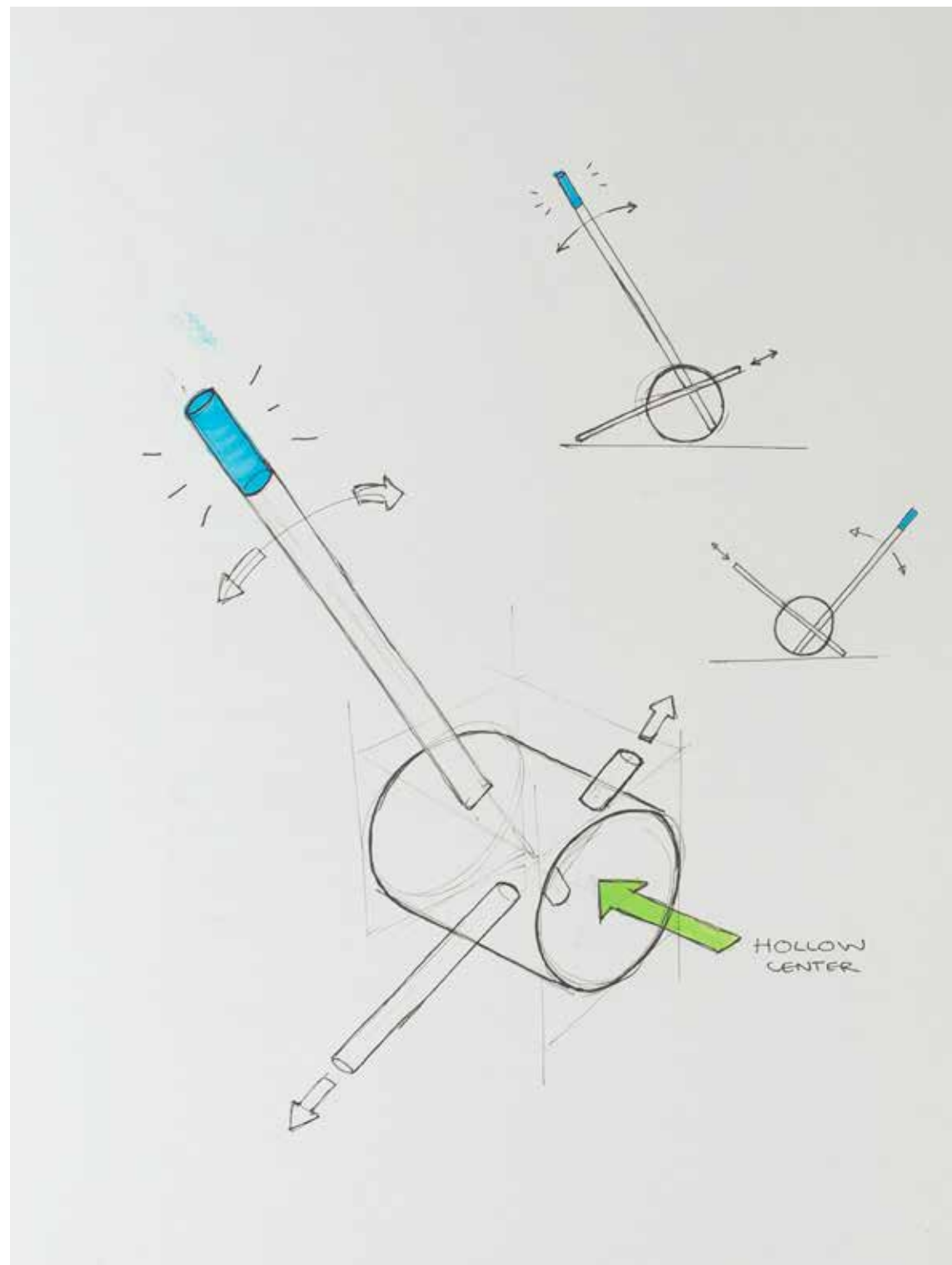
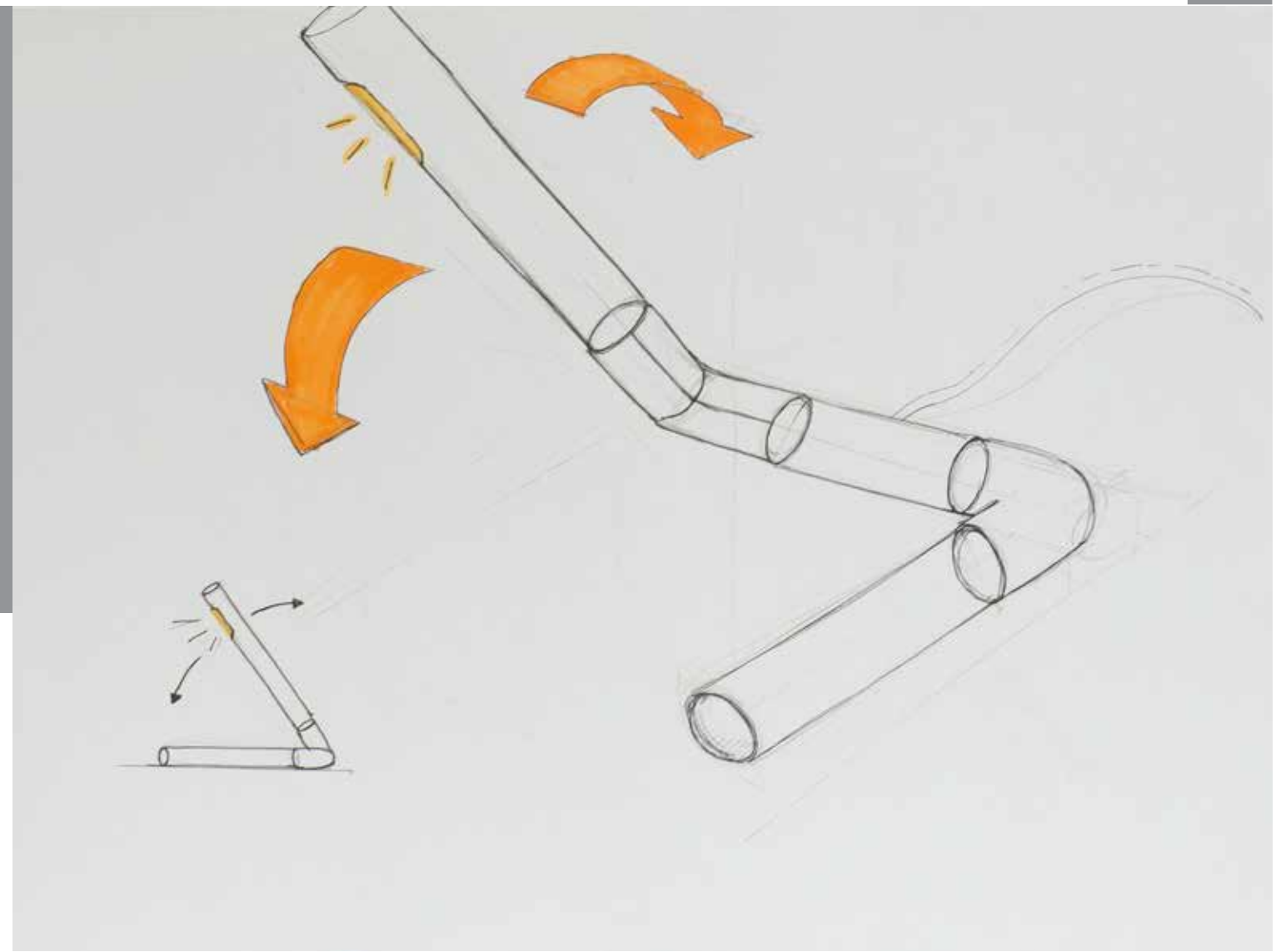

DEFINING SHAPE AND ASSEMBLY

Defining bulb shape and positioning of the LED inside of resin mold

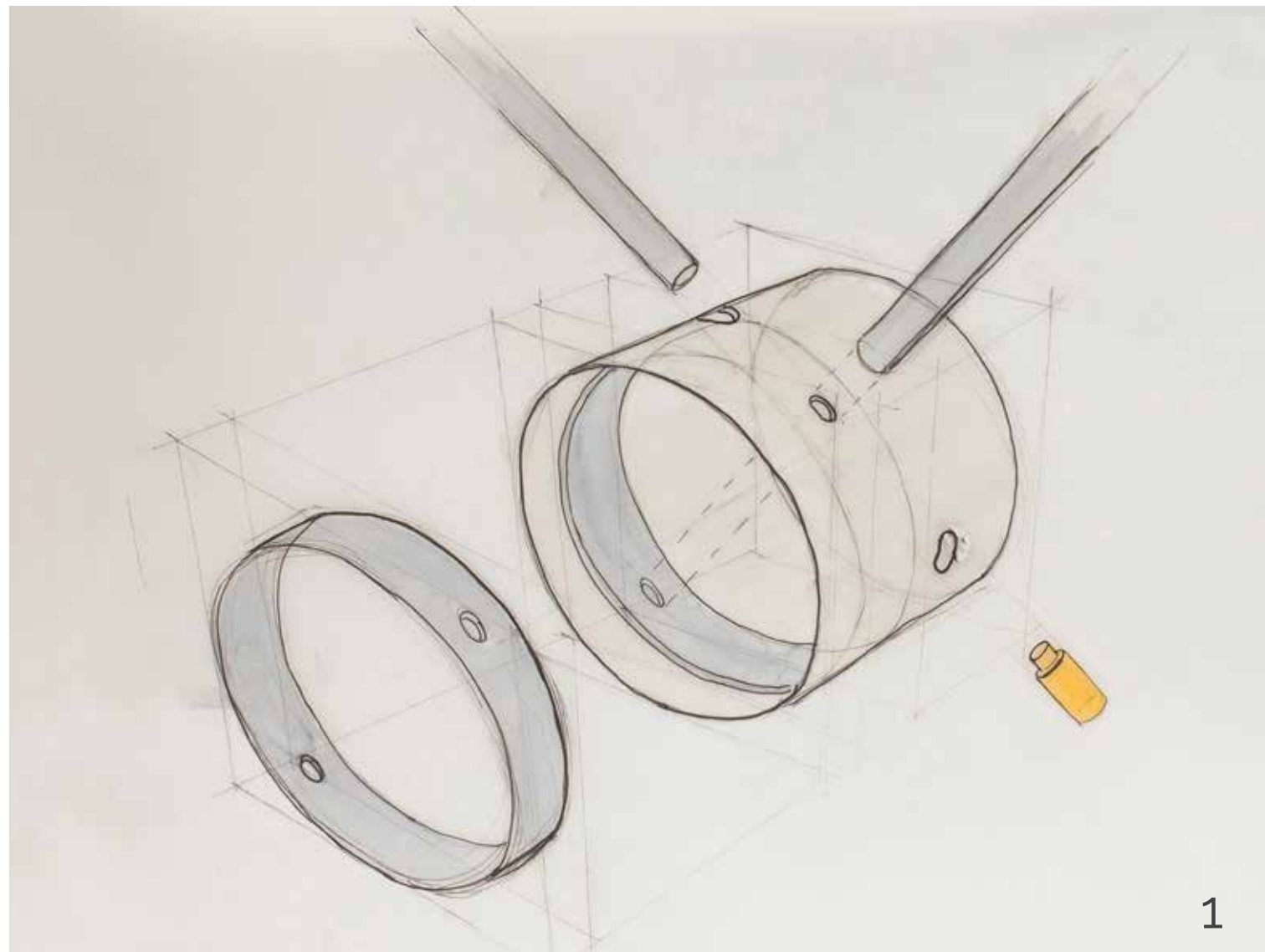
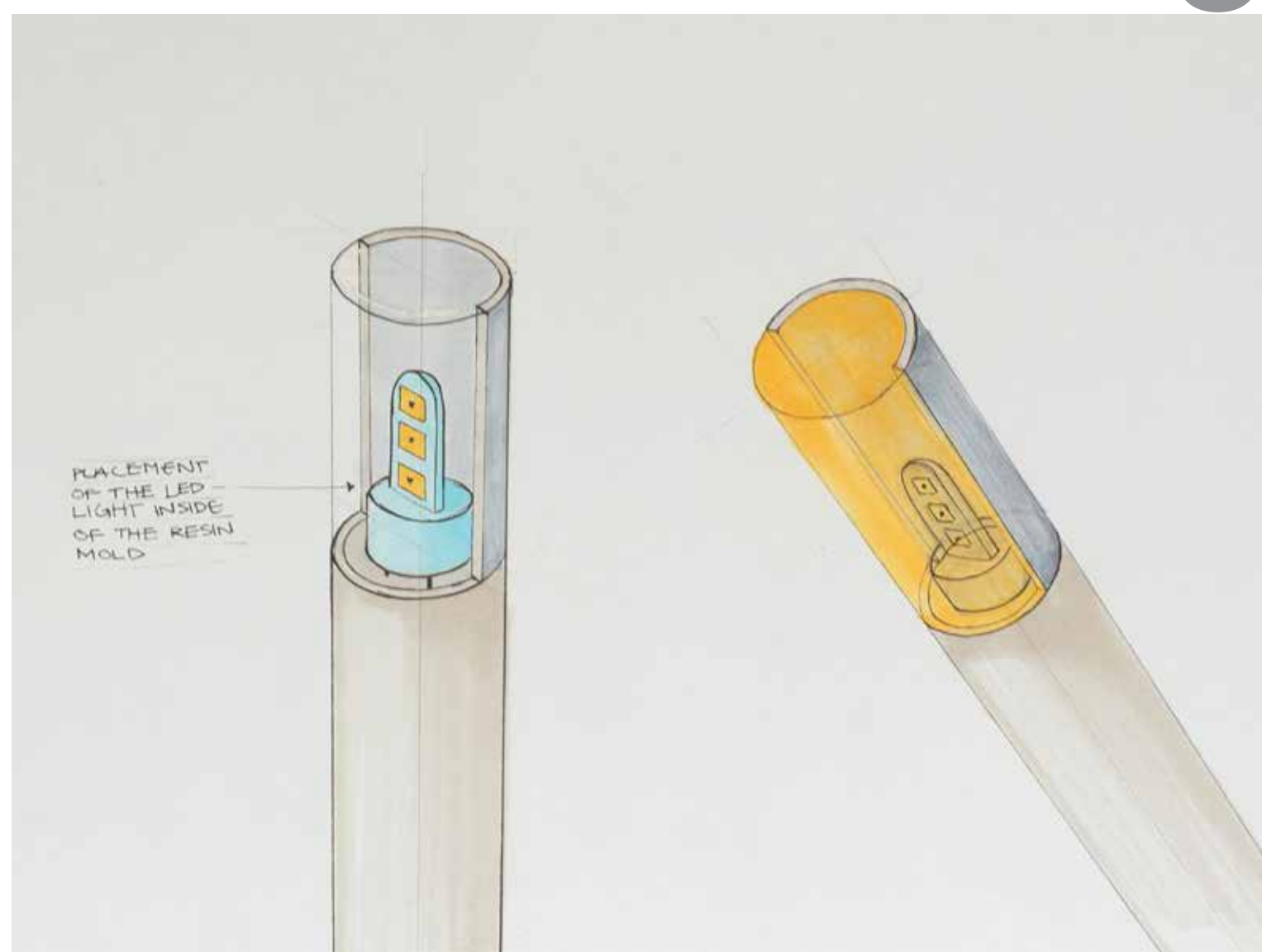
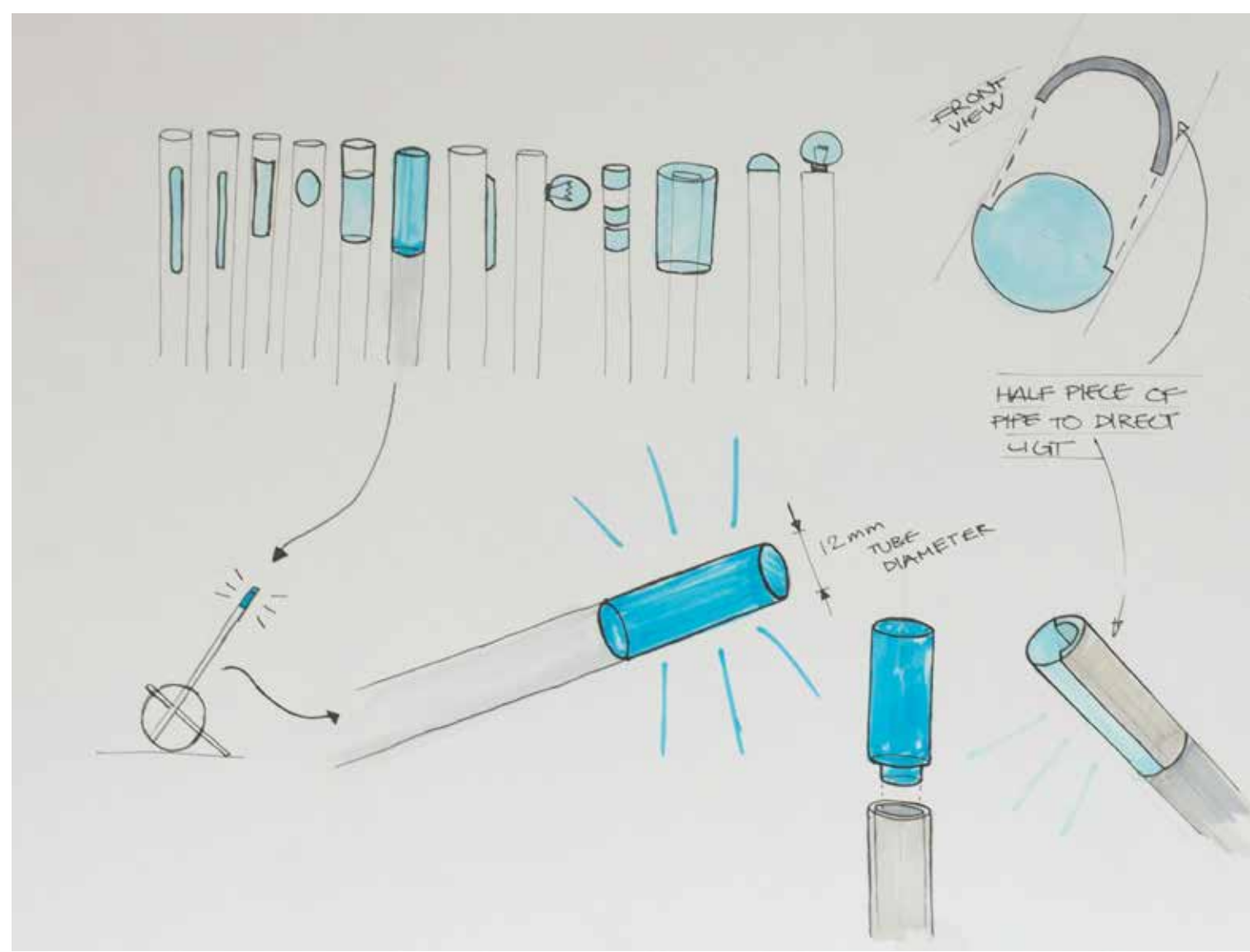

1

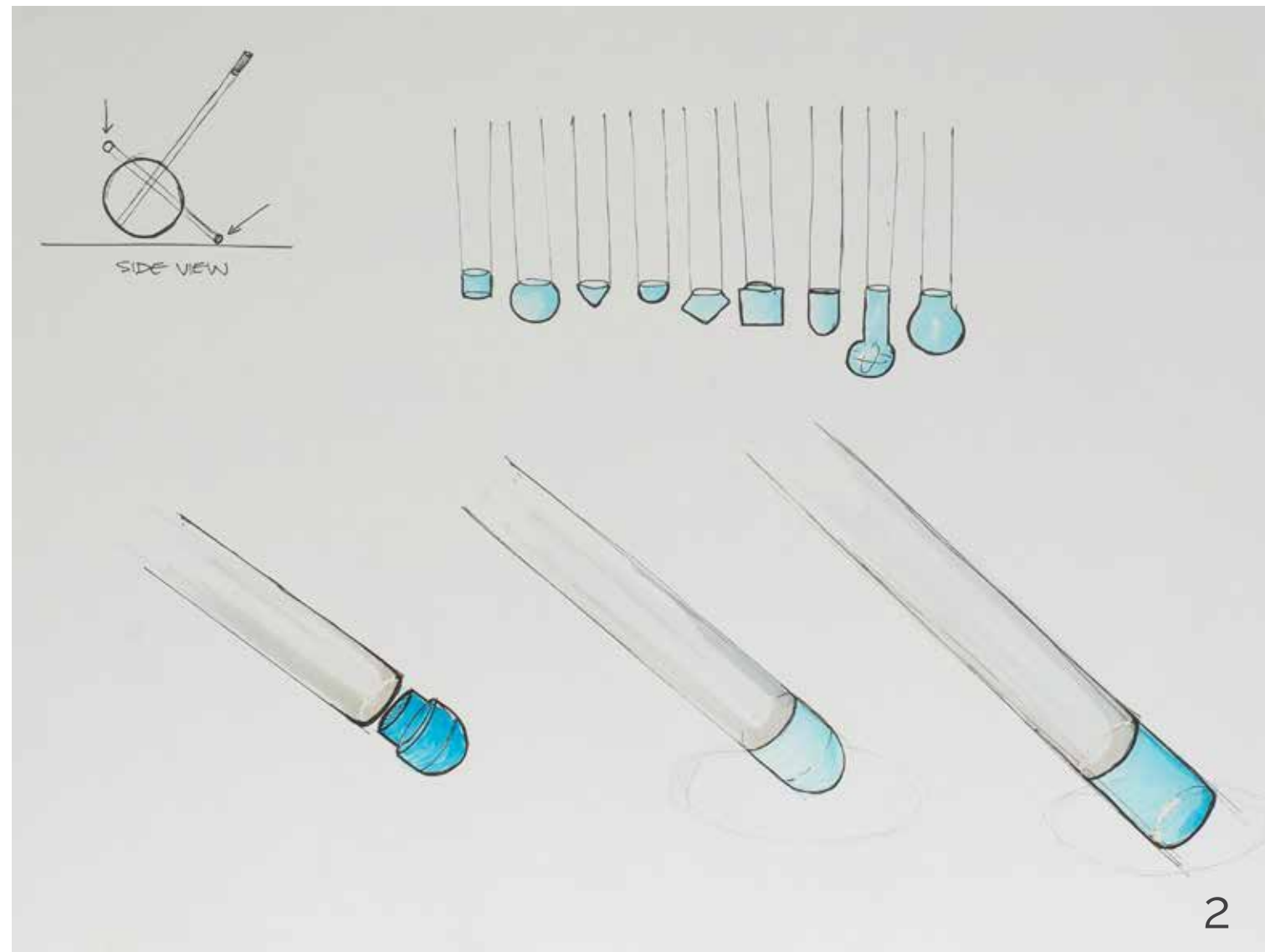

2

1-Assembly of the pipes to the core
 2-Legs shape and assembly

MANUFACTURING

1-PVC pipes collected from the trash of a construction site.

2-First prototype of the lamp

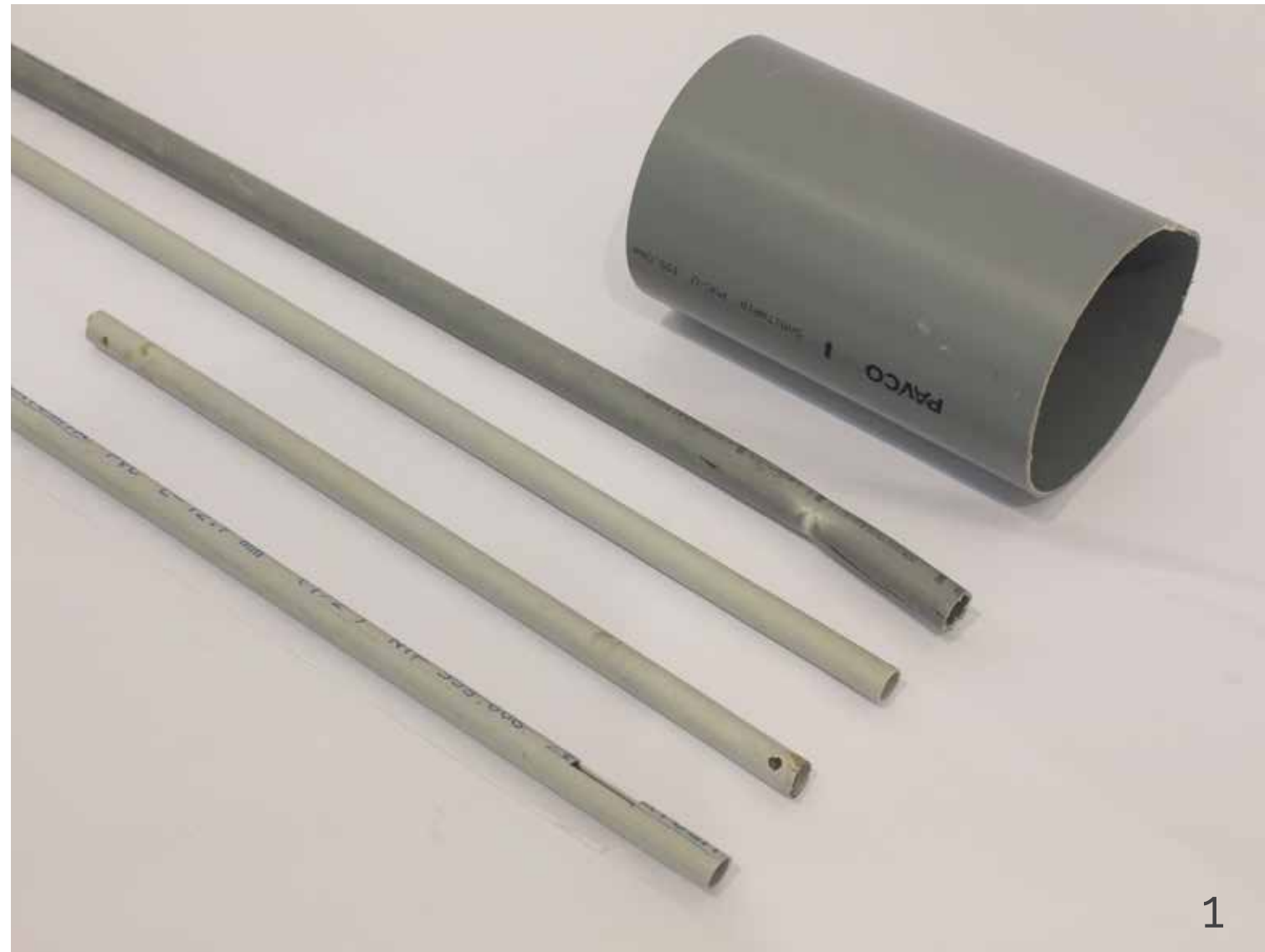

LIGHT ANGLE ADJUSTMENT

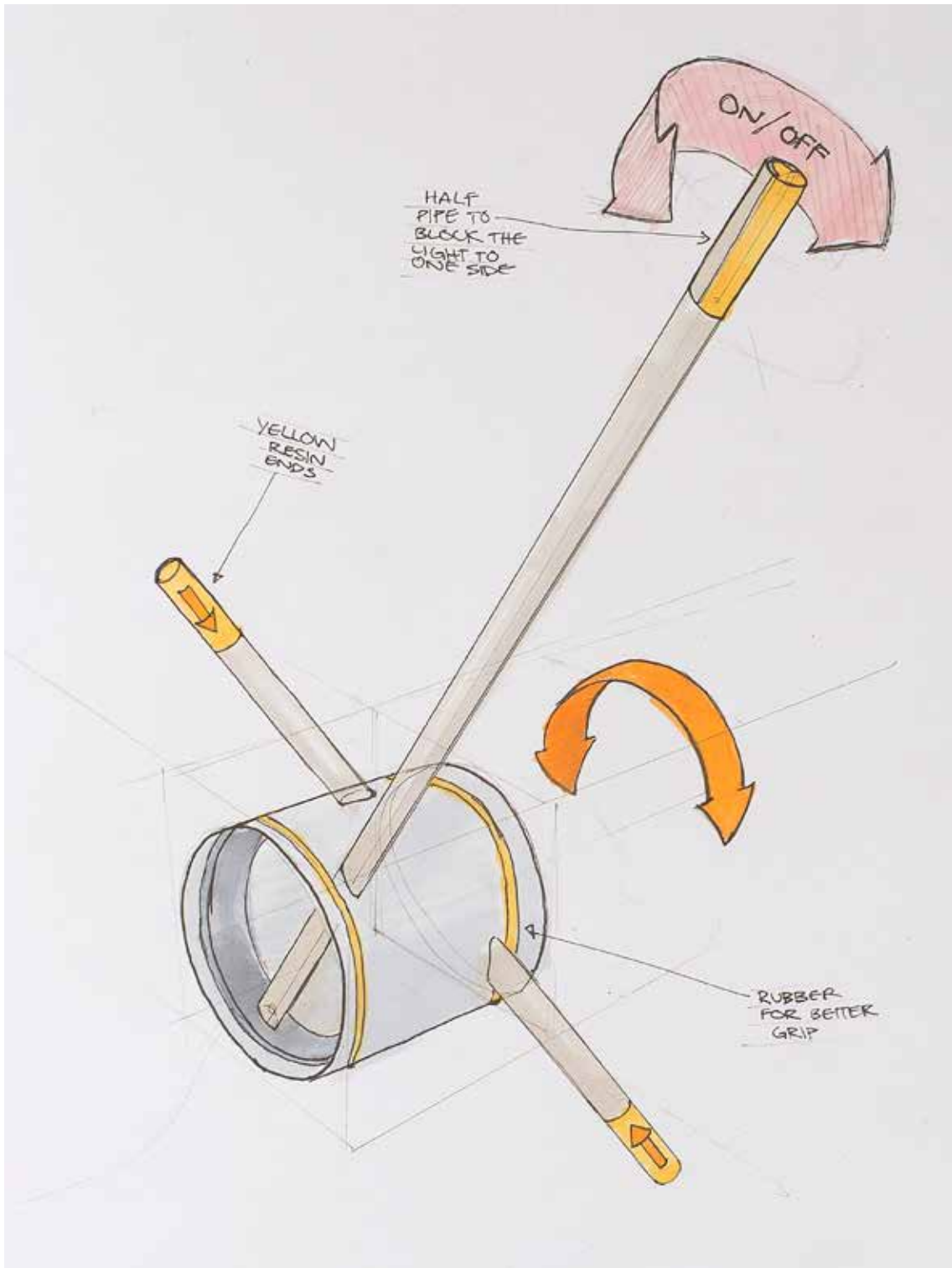

FINAL PRODUCT

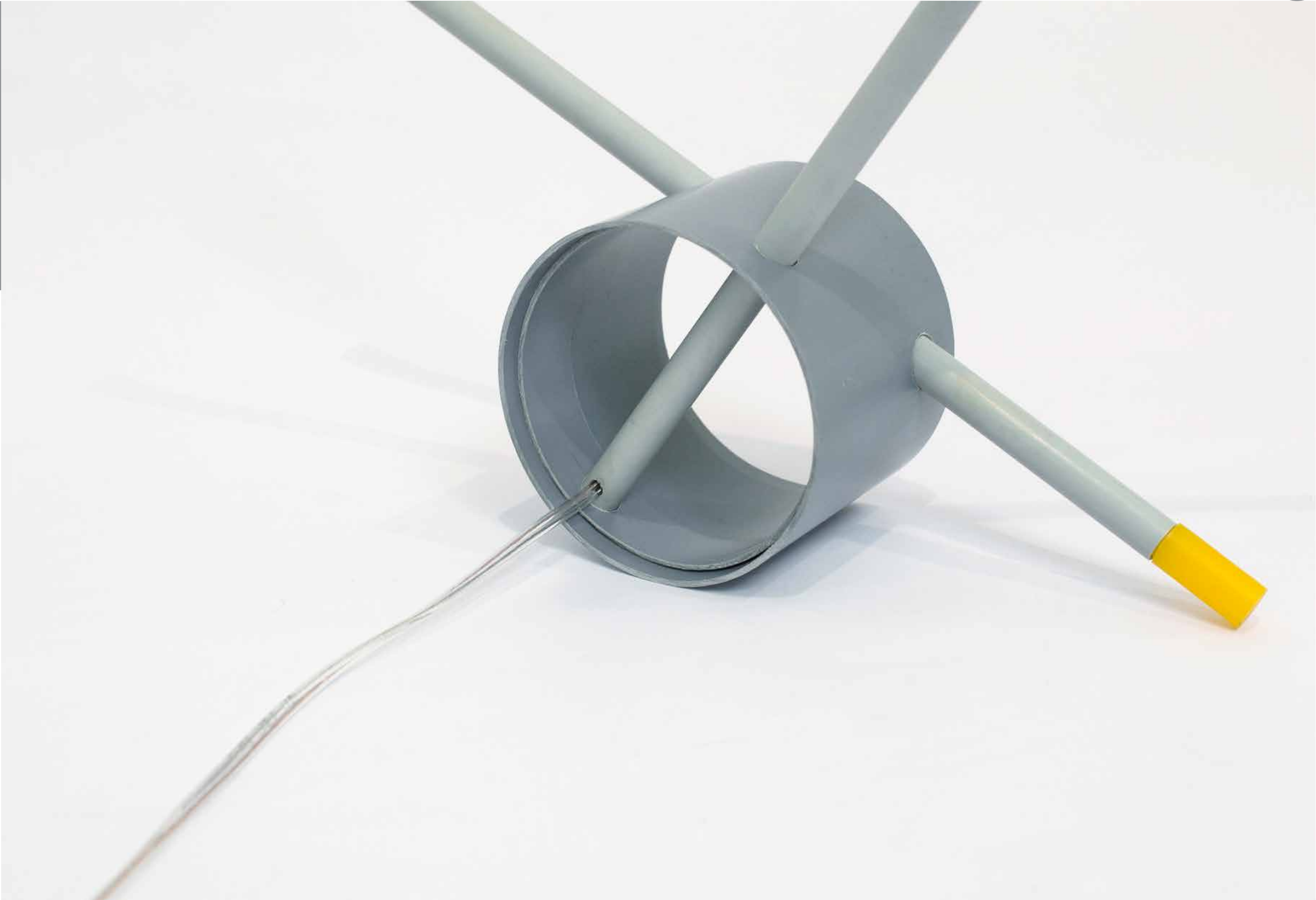

SURF COMB



PROJECT SUMMARY

I'm a surfer and a situation I face every time I go surfing is having to either comb or scrape the wax off of my surfboard. Existing surf combs are not ergonomically designed in my opinion, therefore using them is uncomfortable and often painful.

I wanted to design a surf comb that was ecofriendly and comfortable to use. I wanted it to have many sharp sides and to be easy to use.

DESIGN PROCESS

I started by studying the relationship of the hand with the comb I currently use. Then I sketched different possible solutions and crafted a prototype myself out of a bamboo flooring plank.

May 2019

BACKGROUND RESEARCH



PROS
Made from wood

CONS
Has many sharp sides therefore is not comfortable to handle



Most widely used surf comb among surfers



PROS
Thought design with hand analysis

CONS
Too small
Exces material if made from wood

Existing surf combs are uncomfortable and even painful to grip
Stress on finger tips and palm while utilizing it



STUDY OF INTERACTION

Sketches of the relationship between the hand and existing surf combs.

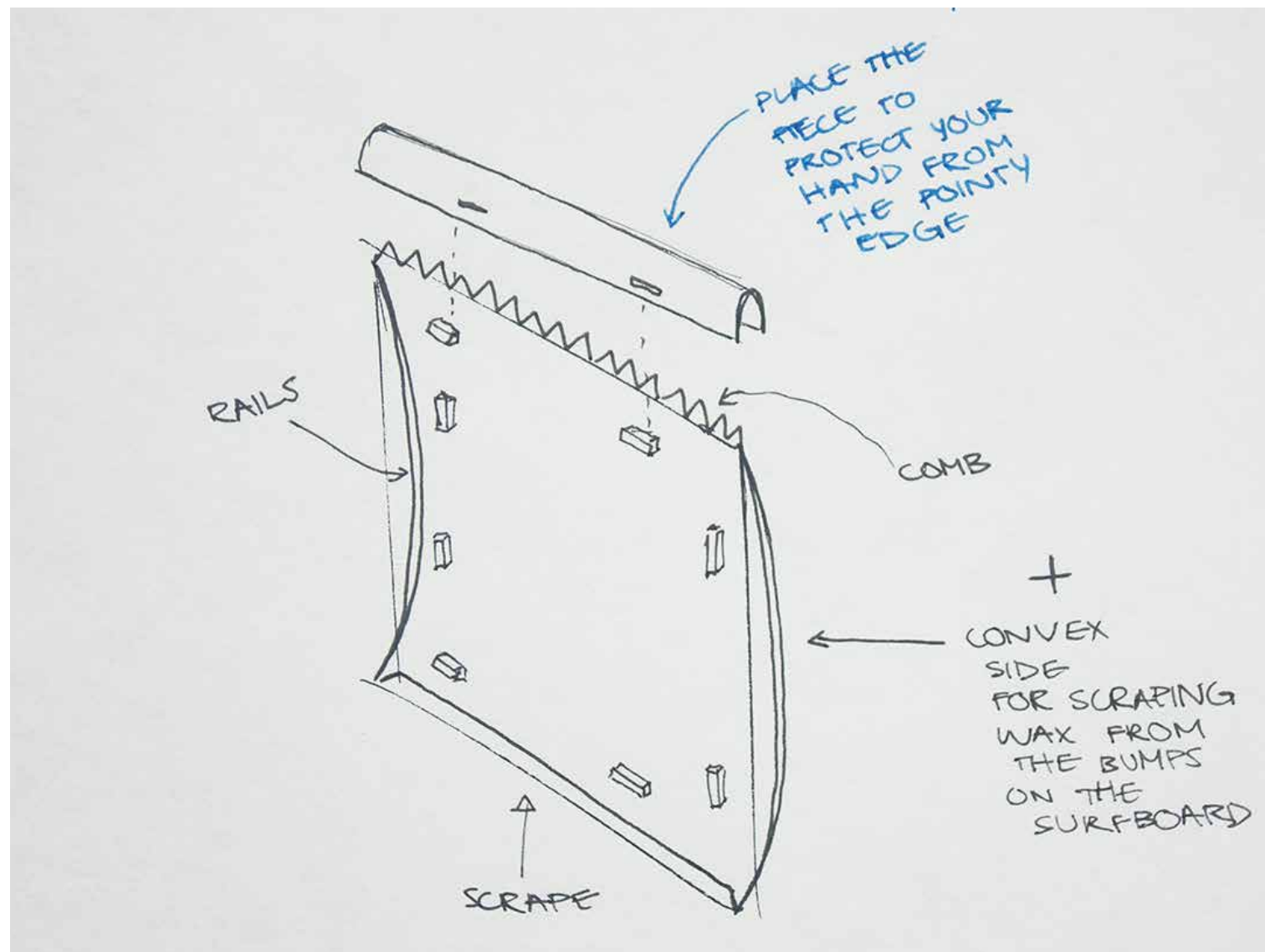
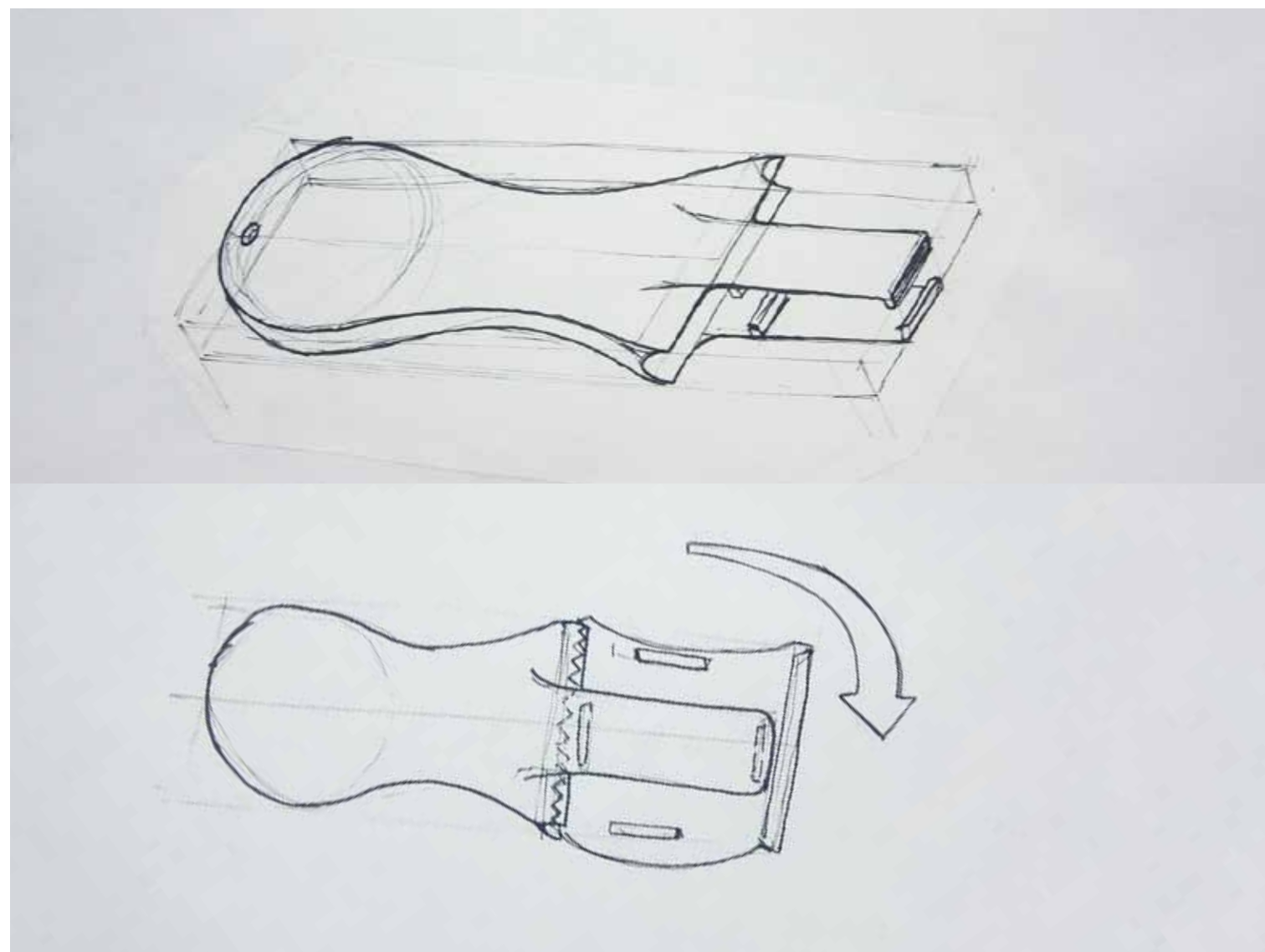
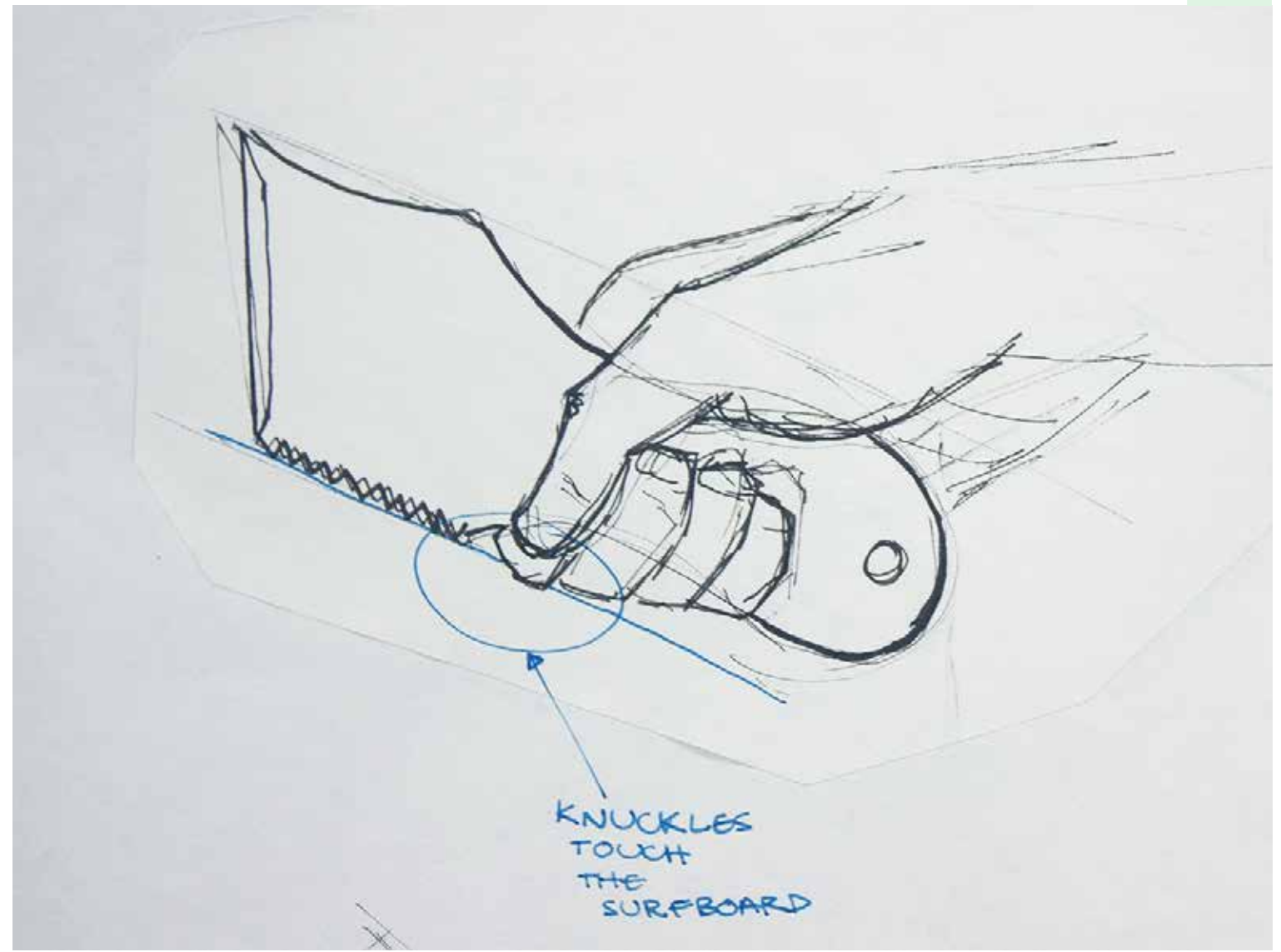
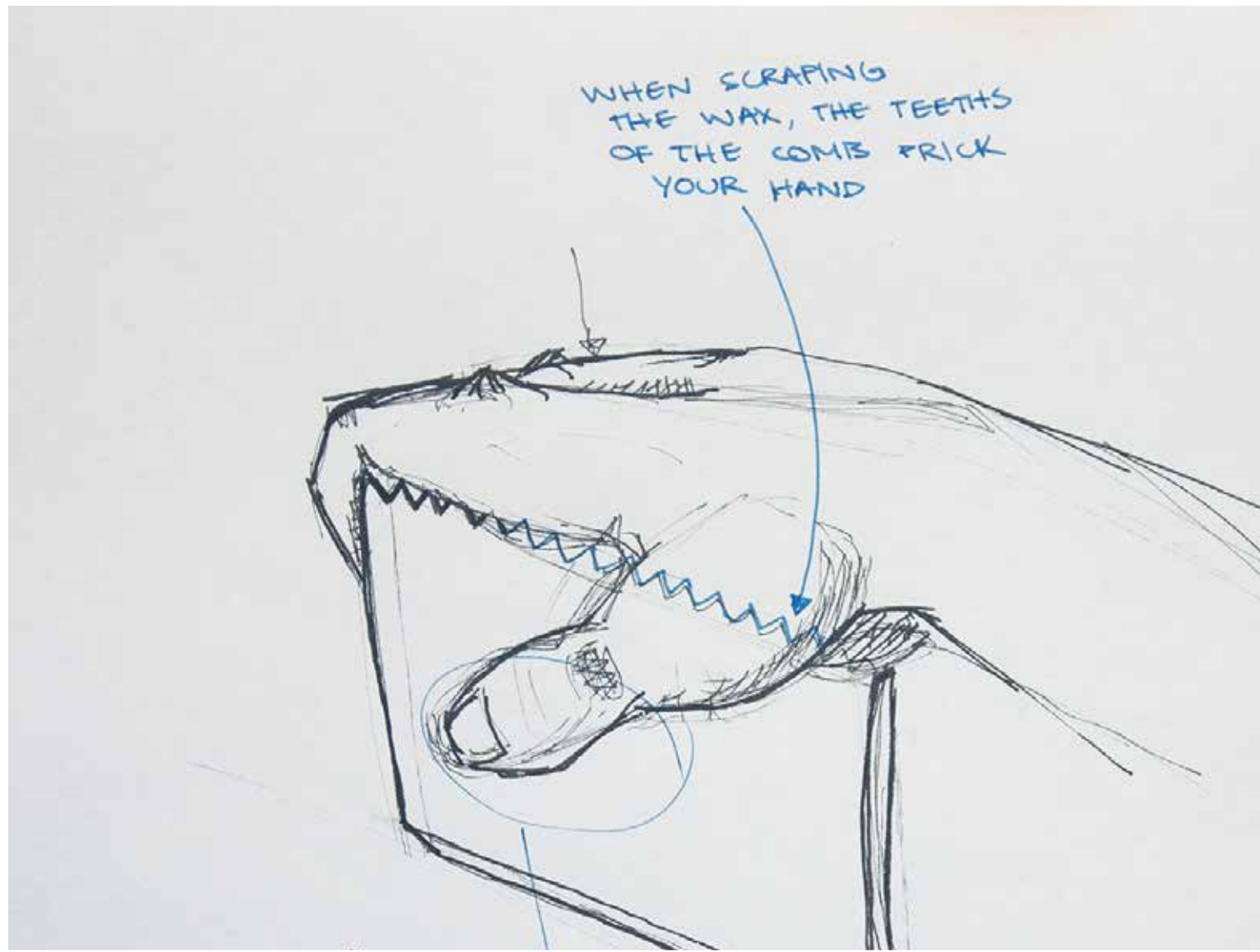

IDEATION

Exploring clipping mechanisms to enable the rotation of the comb and the grip side

IDEATION

I started by studying the relationship of the hand with the comb I currently use.

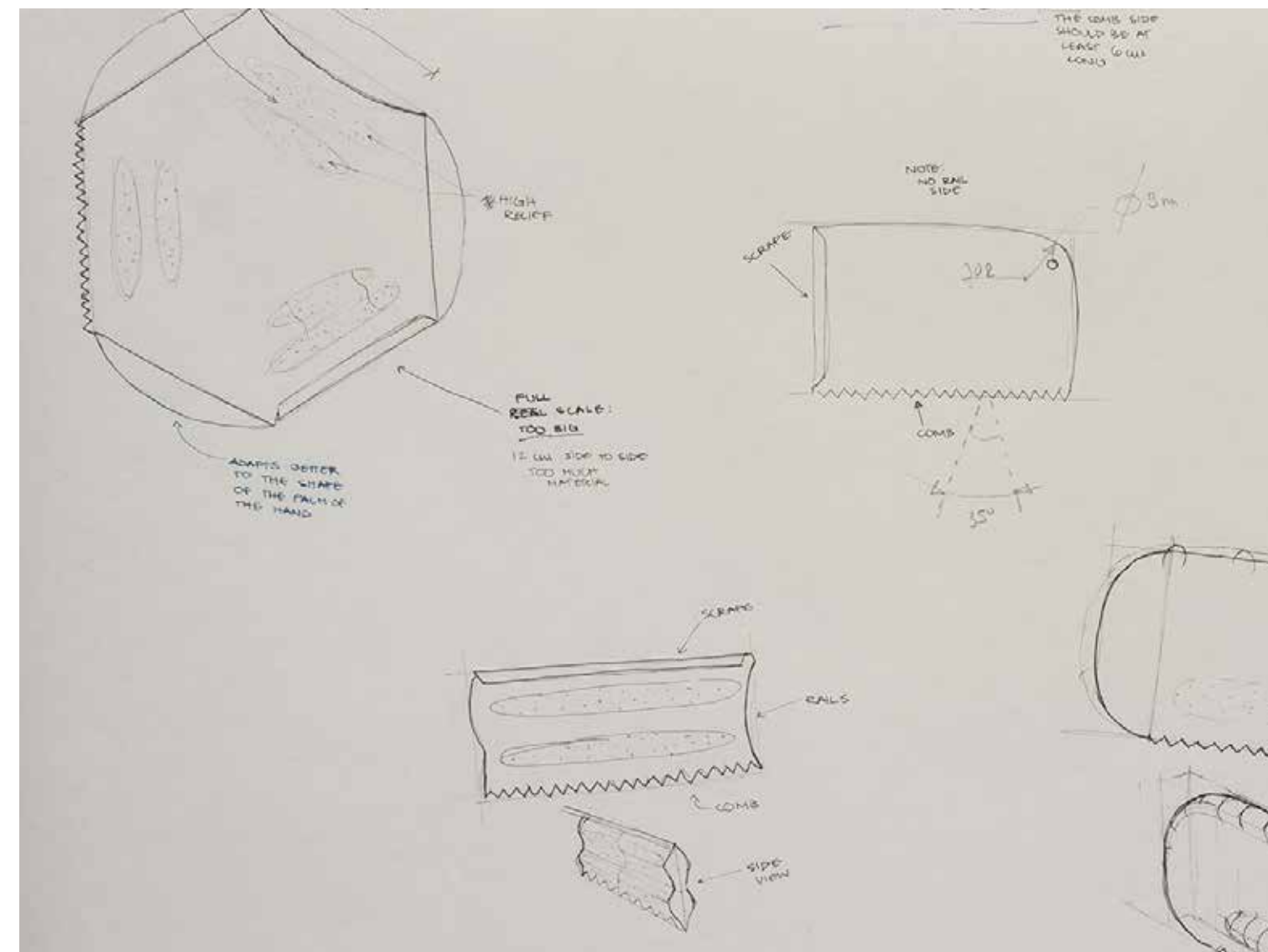
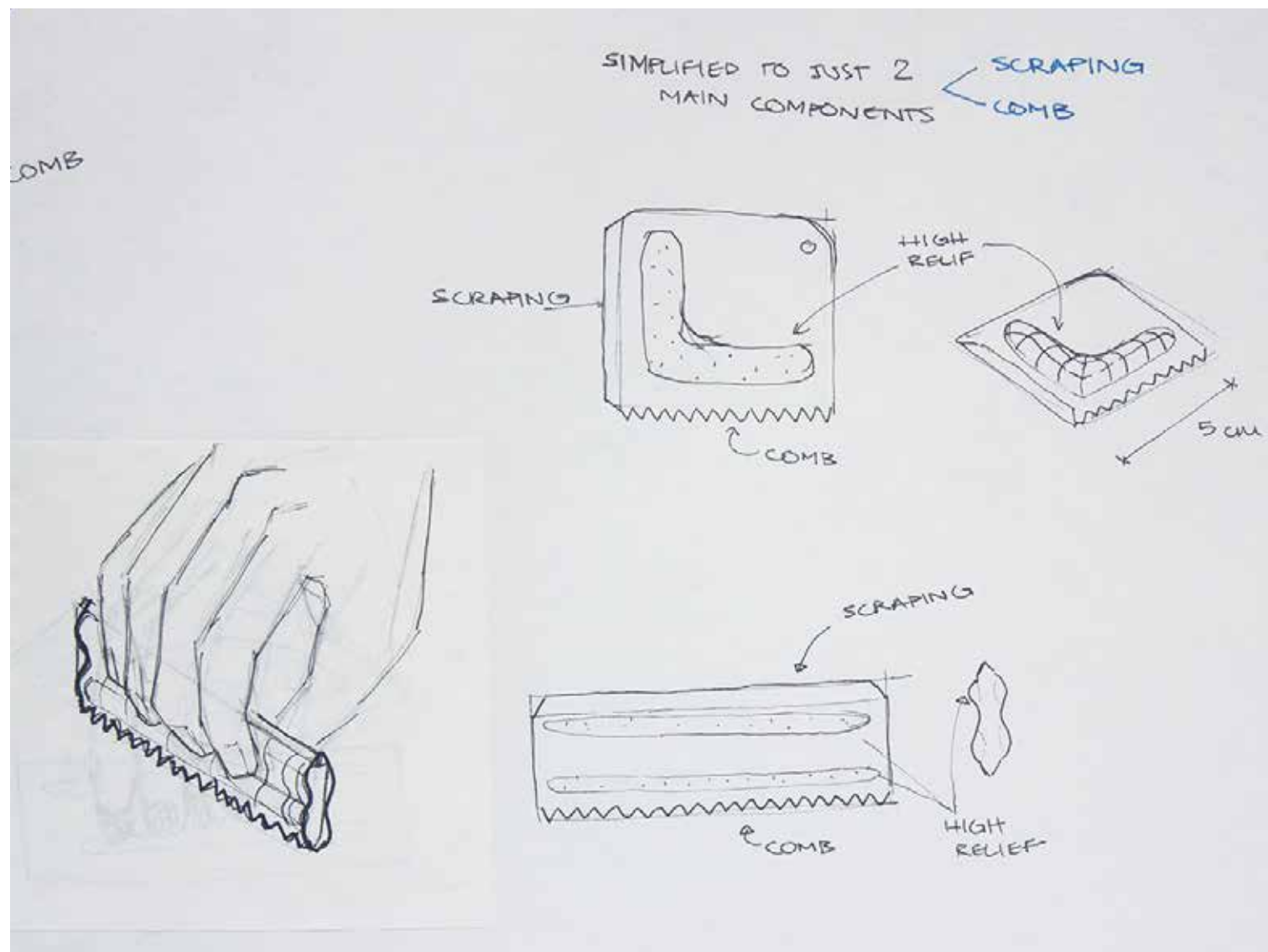
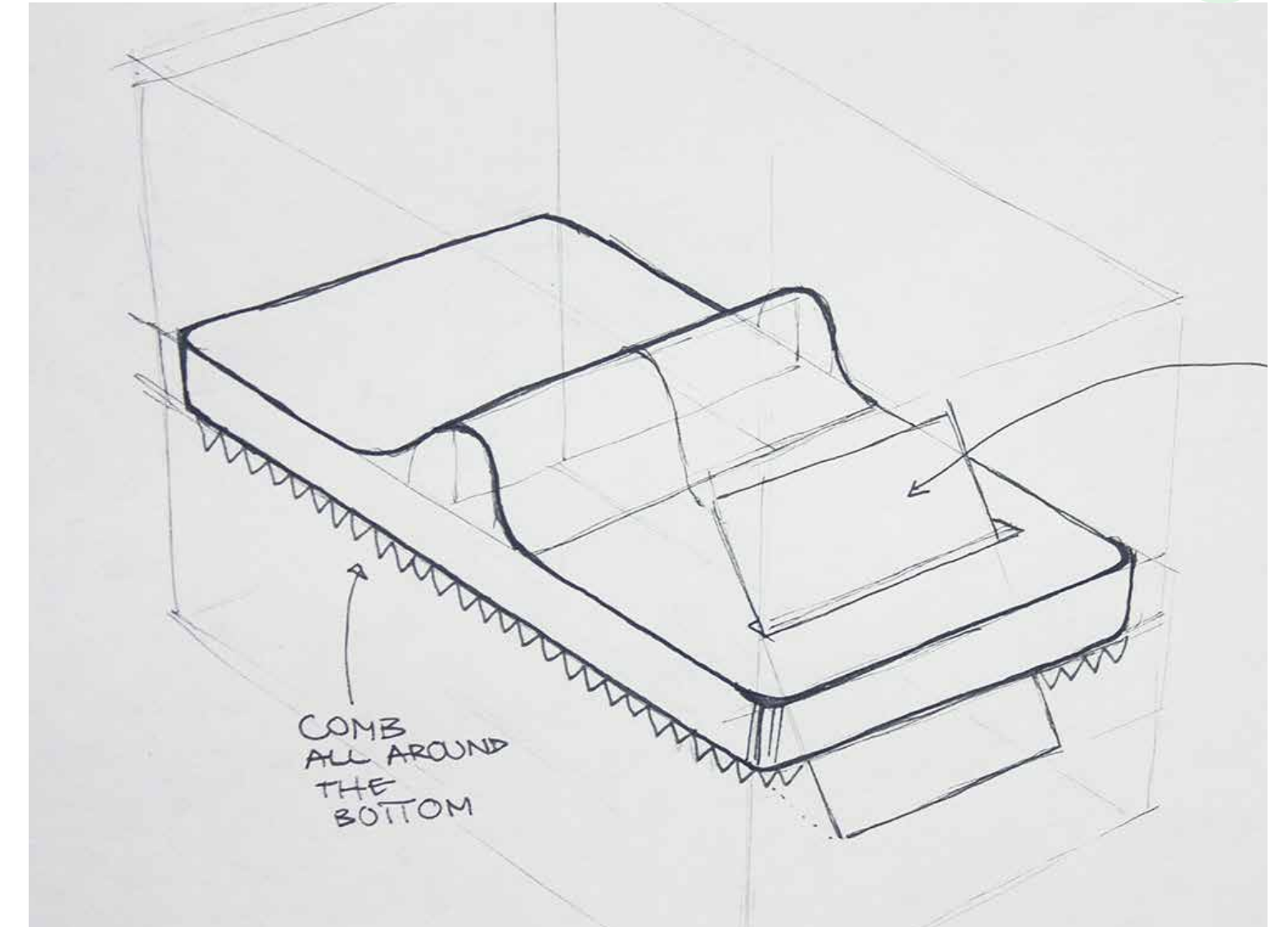
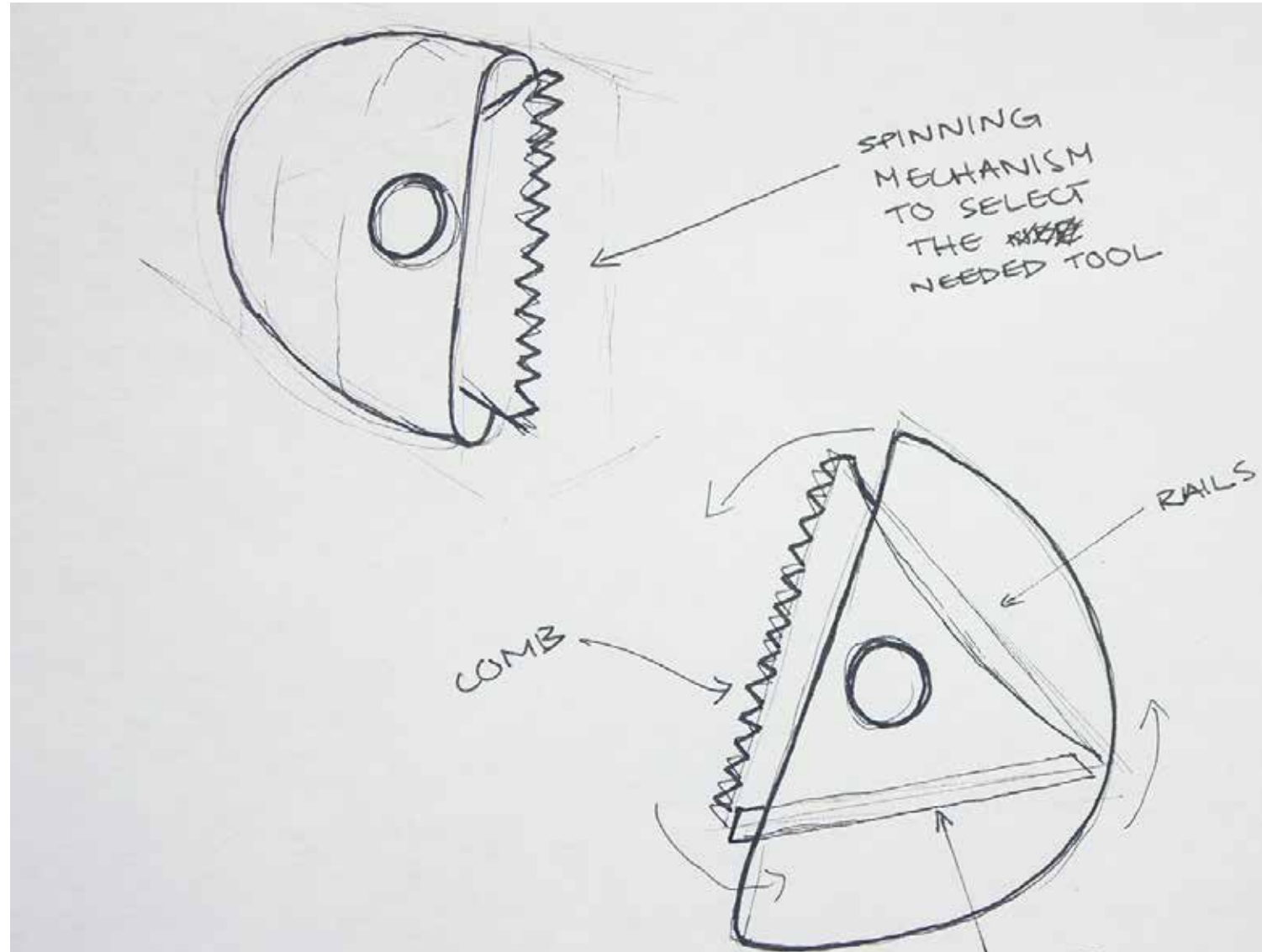

Alternative designs without movable parts or mechanisms

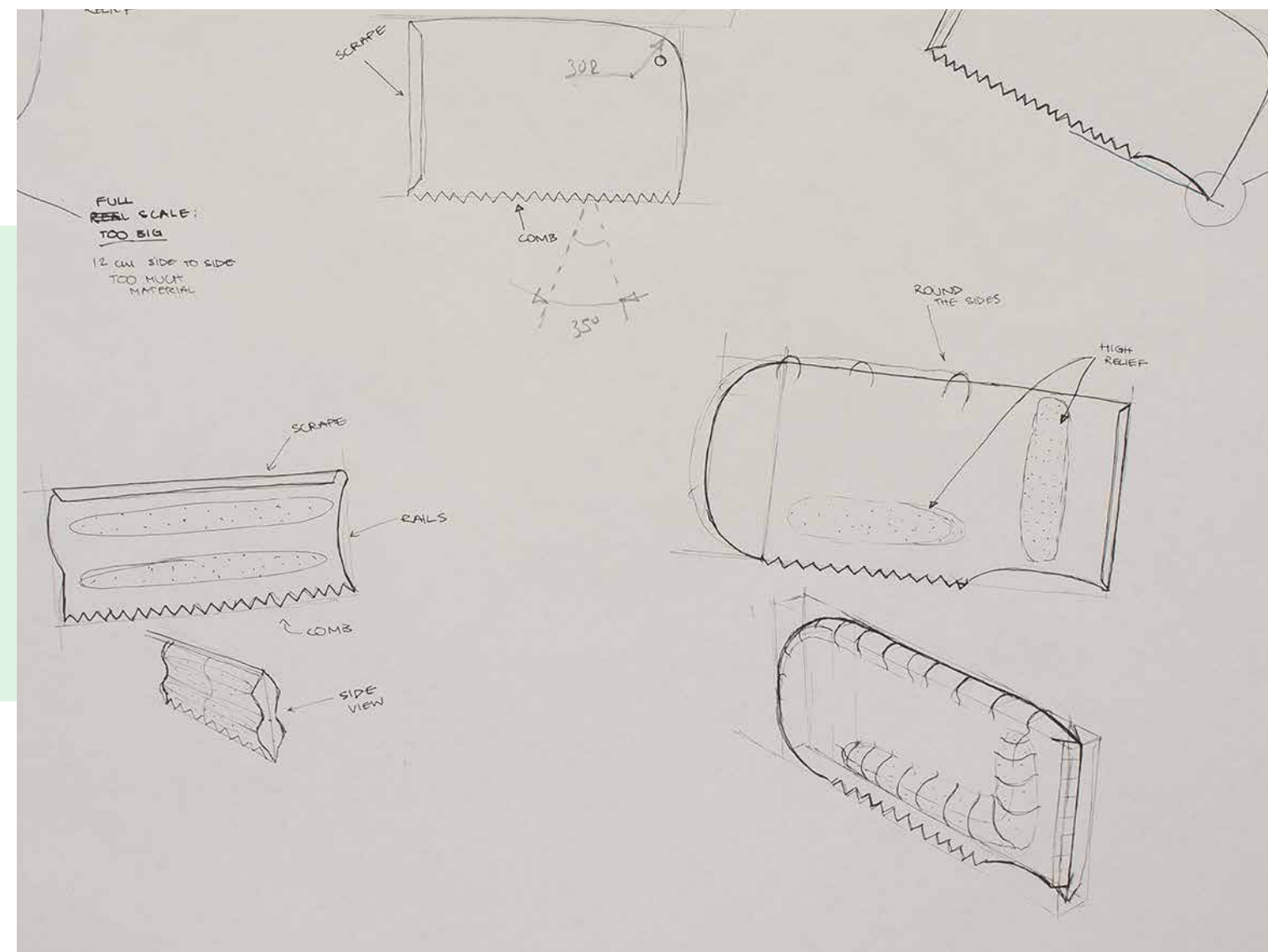
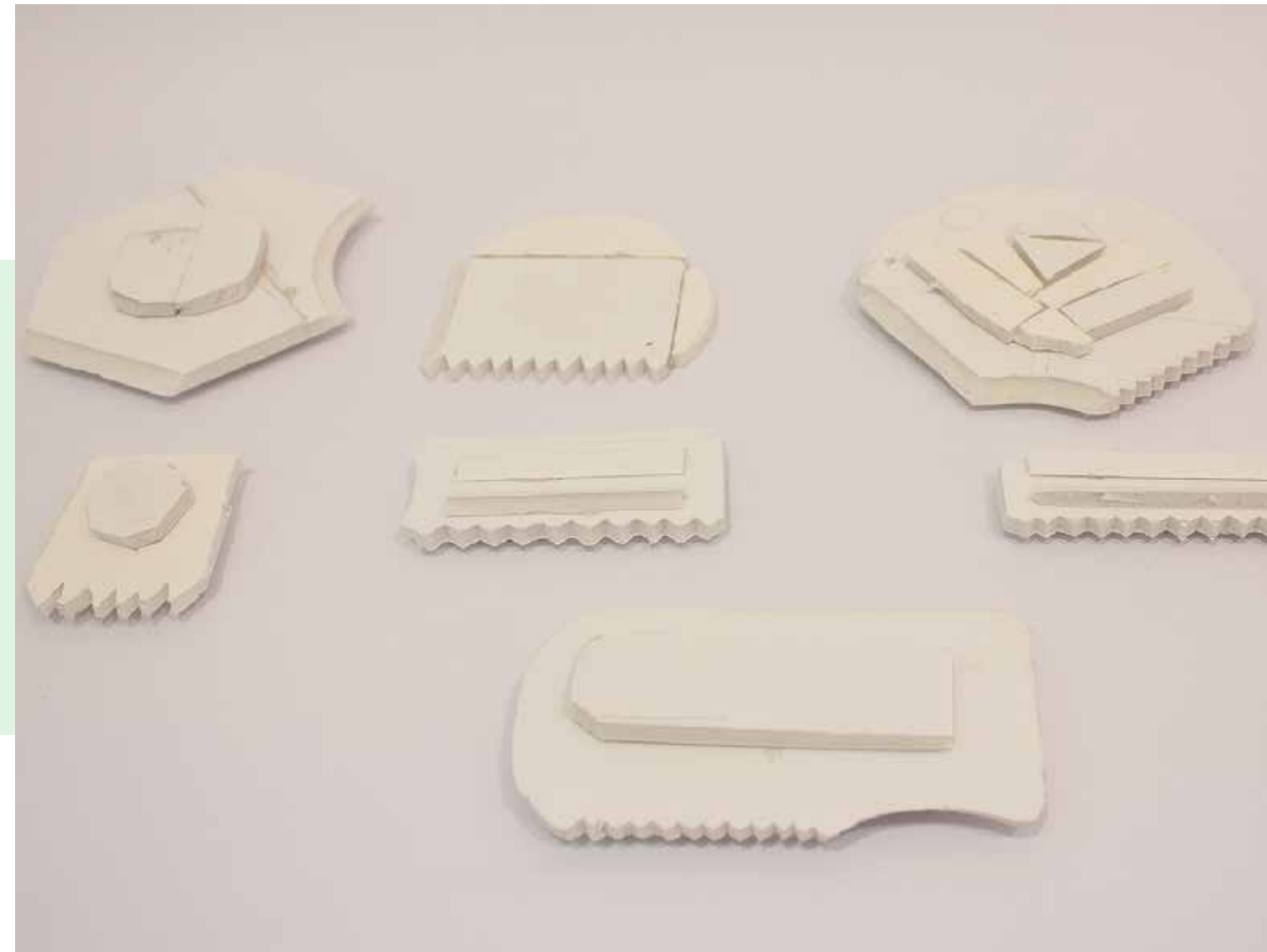
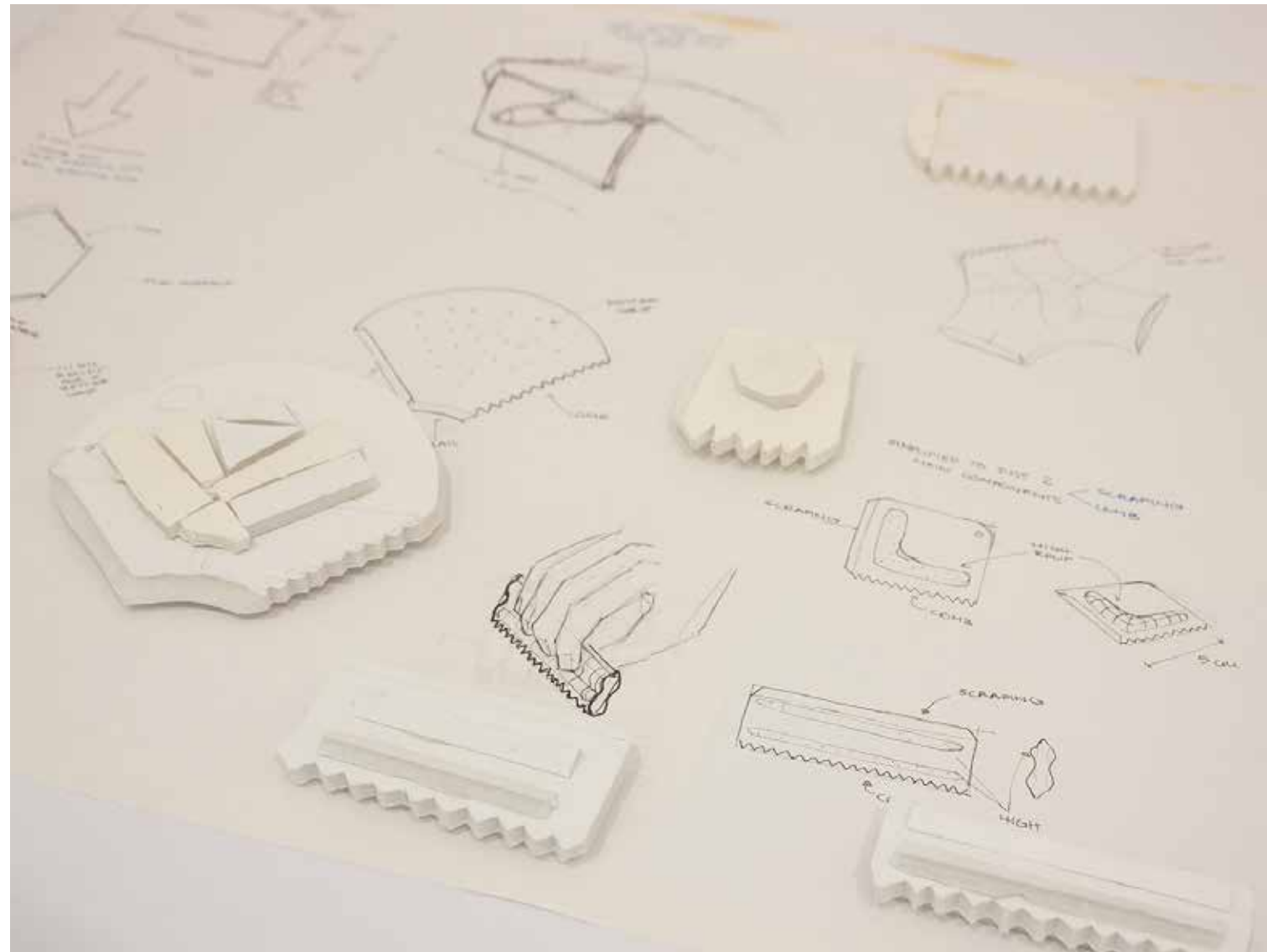

PROTOTYPING AND FINAL SKETCHES

Styrofoam prototypes were built, to test for comfortability and usability

Then I chose the most comfortable one and drew up the final blueprints to build the end product

FINAL PRODUCT

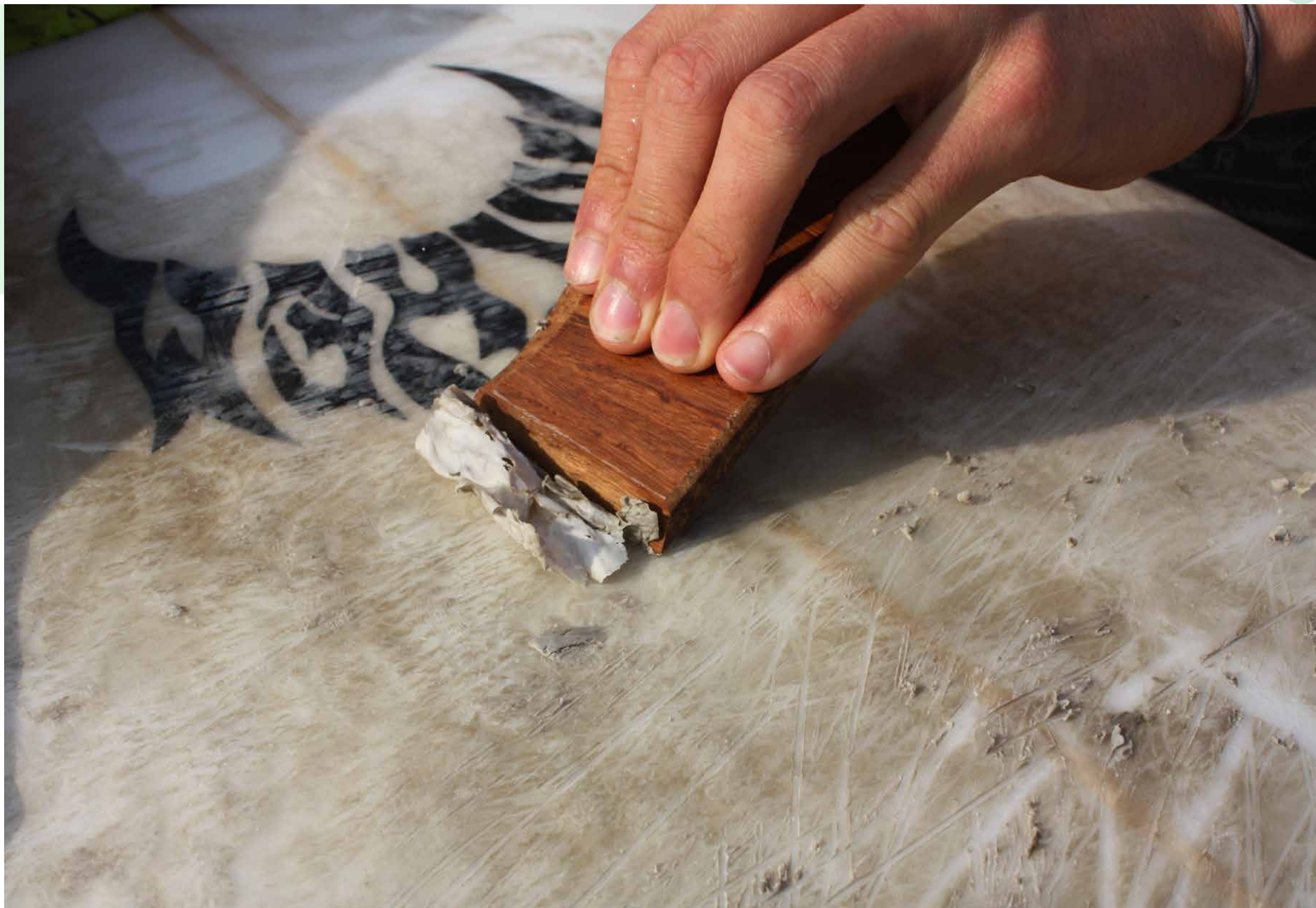

EARPHONE WINDER



PROJECT SUMMARY

Cable winders to prevent tangled earphones already exist, but they have a major problem: when you unroll the earphones, you end up with two separate parts, the winder and the earphone, which makes it easy to lose the winder. My design is an attempt to combine the winding function, with a mechanism that keeps the winder attached to the earphone when unwound.

DESIGN PROCESS

I did the initial research to find existing products and their major problems. Then sketched possible solutions, and built prototypes of different materials. Finally, I built the end product.

I considered different materials searching for lightness of weight, ranges of flexibility, durability and eco-friendliness.

April 2019

BACKGROUND RESEARCH

Nothing really keeps the earphone from unrolling



Both keep the earphone winded and secured

But you can not use the earphone while keeping it attached to the winder

EXPLORATORY SKETCHES

Main shape and mechanism to keep the winder attached to the cable at all times

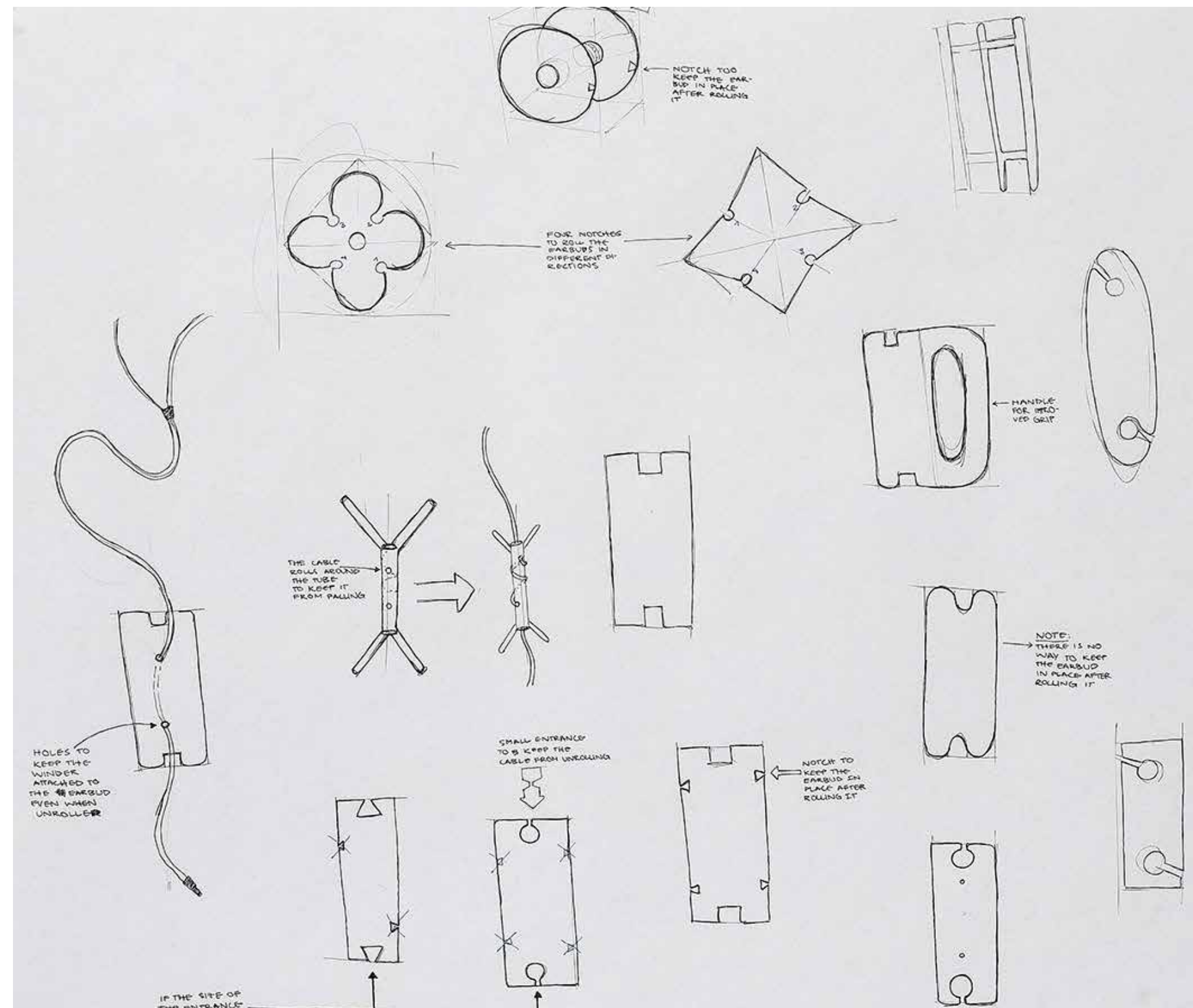

DEFINING THE FINAL SHAPE

It had to be aesthetic since it would be hanging from the earphones when someone was using them.

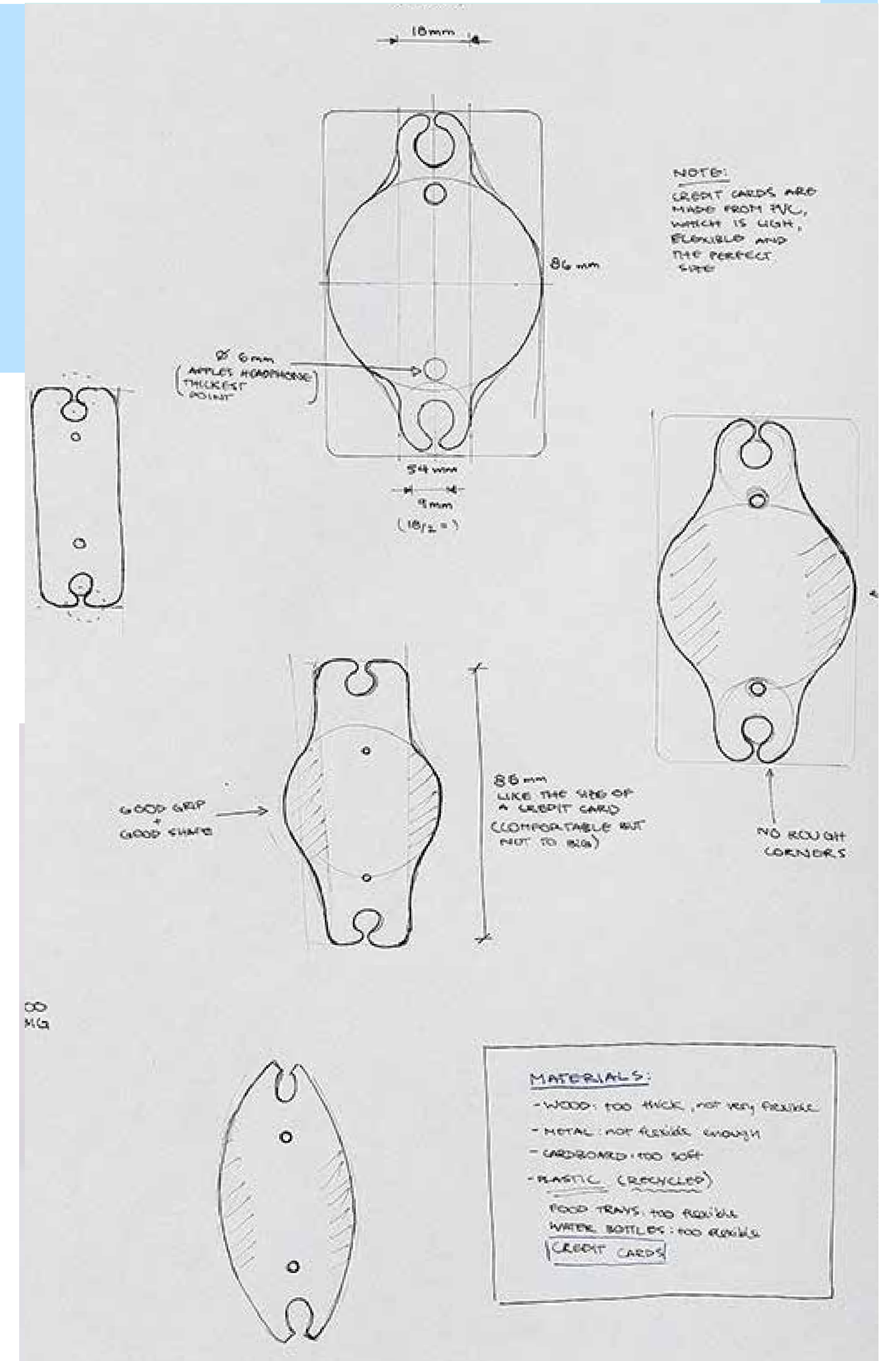
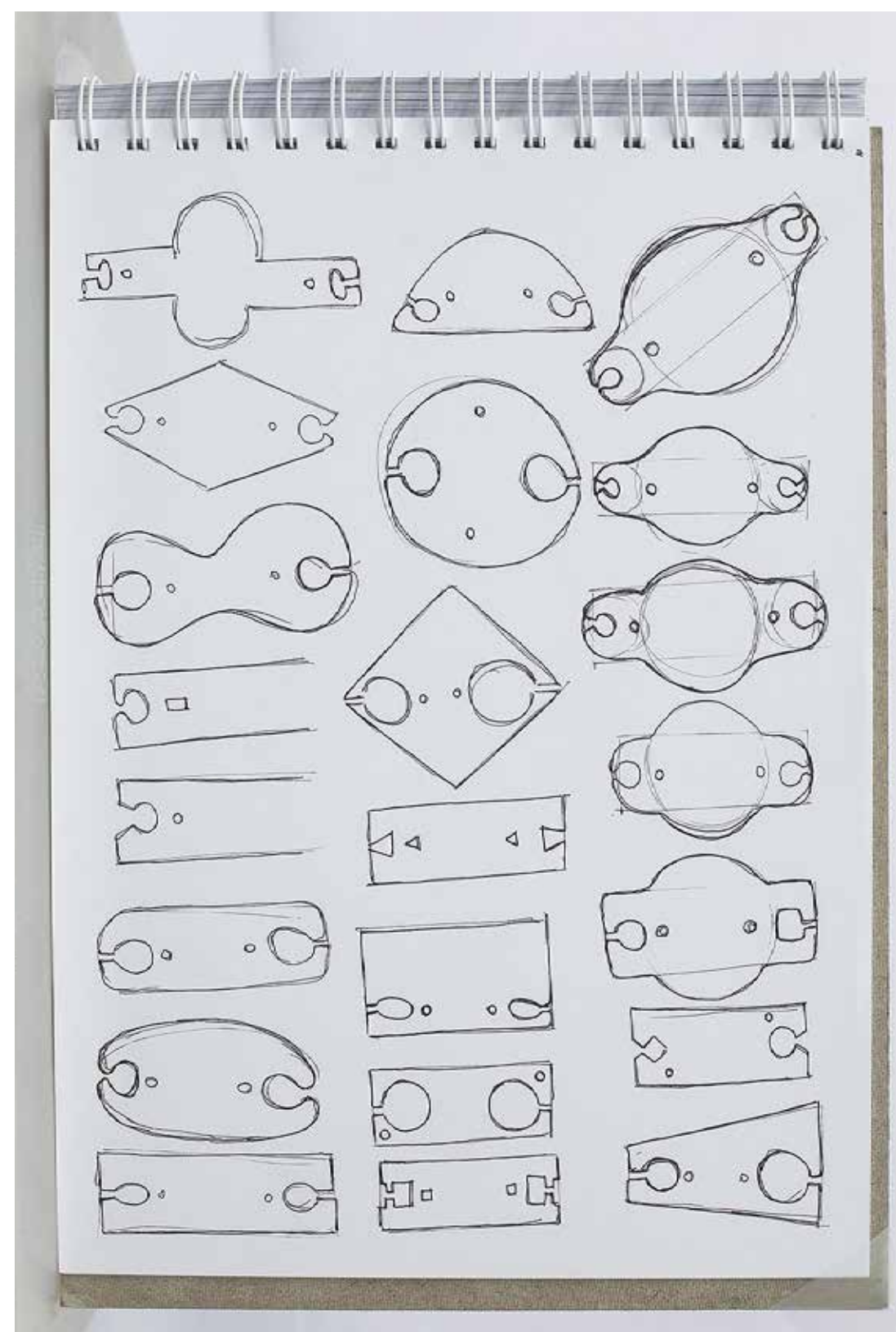

DEFINING THE FINAL MATERIAL

I explored with different materials searching for lightweight, ranges of flexibility, durability and ecofriendliness.

MANUFACTURING

After choosing the credit card as the material for the product, I made the earhpone winder usign a printed template

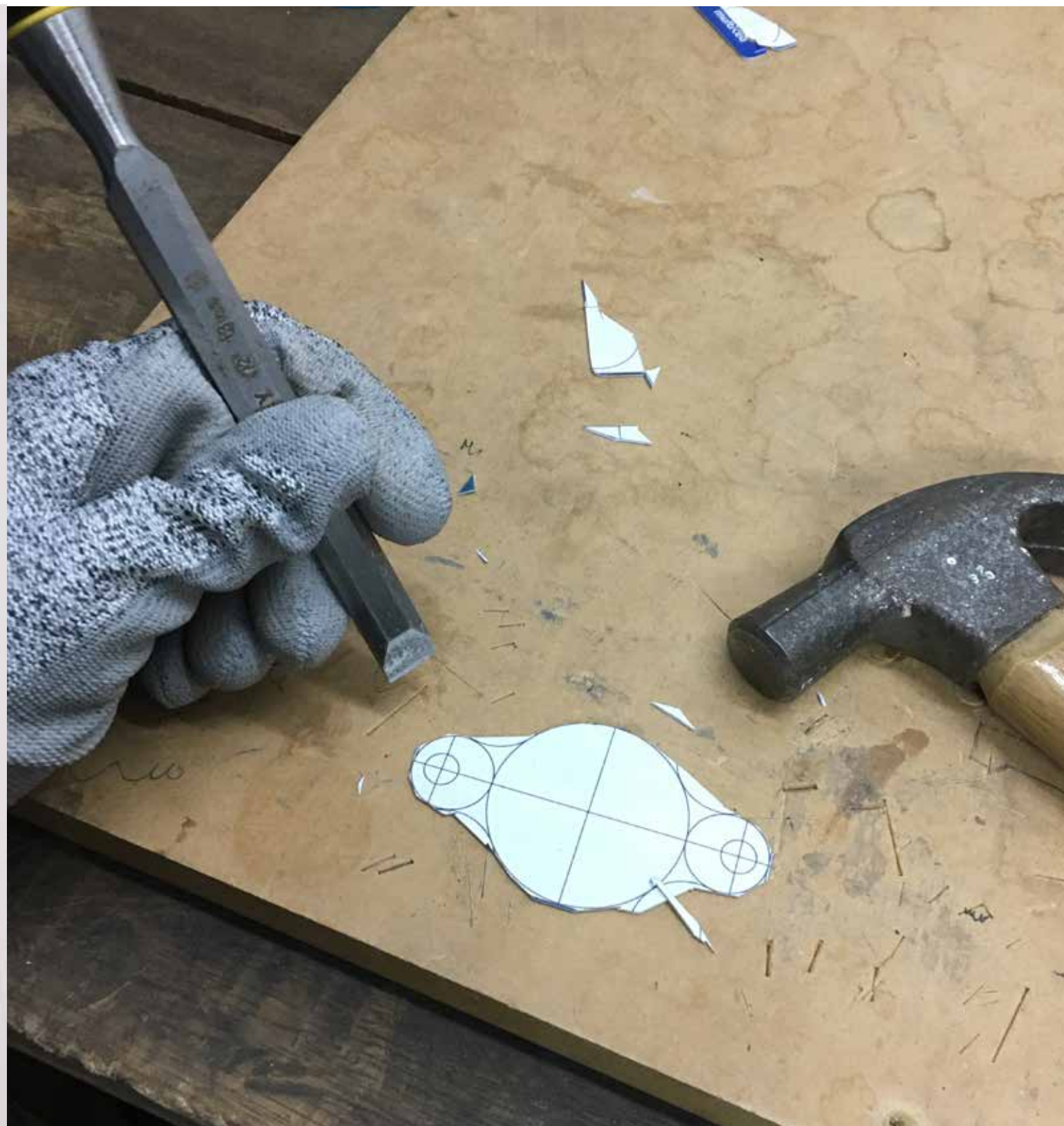
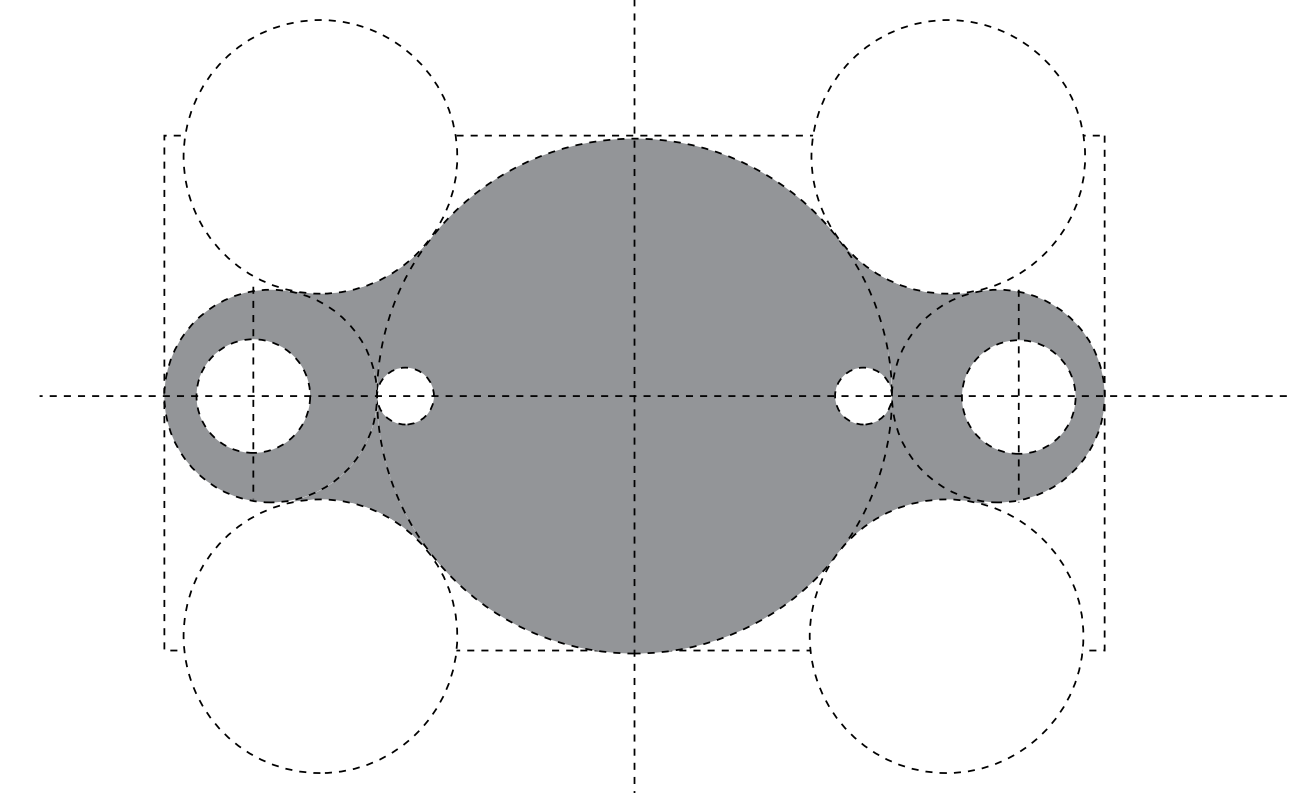

FINAL PRODUCT



BILLBOARD VINYL CASE



PROYECT SUMMARY

I wanted to create a case that was easy to clean, and that was made to last. The case should be thin and easily shippable to the user as well. Most of the pencil cases I have had were made of fabric, and they got easily stained when a marker was uncapped. I had some pieces of PVC vinyl from an old billboard and found it to be the perfect material: strong, lightweight and water/stain proof.

DESIGN PROCESS

Inspired by the way a flat piece of cardboard turns into a box, I designed the 3D shape I wanted to end up with and then made the flat blueprint to cut the piece of vinyl. Then I sent two vinyl pieces to be sewn together with magnets in between.

June 2019

BACKGROUND RESEARCH

Inspiration drawn from cardboard boxes and their self closing mechanism

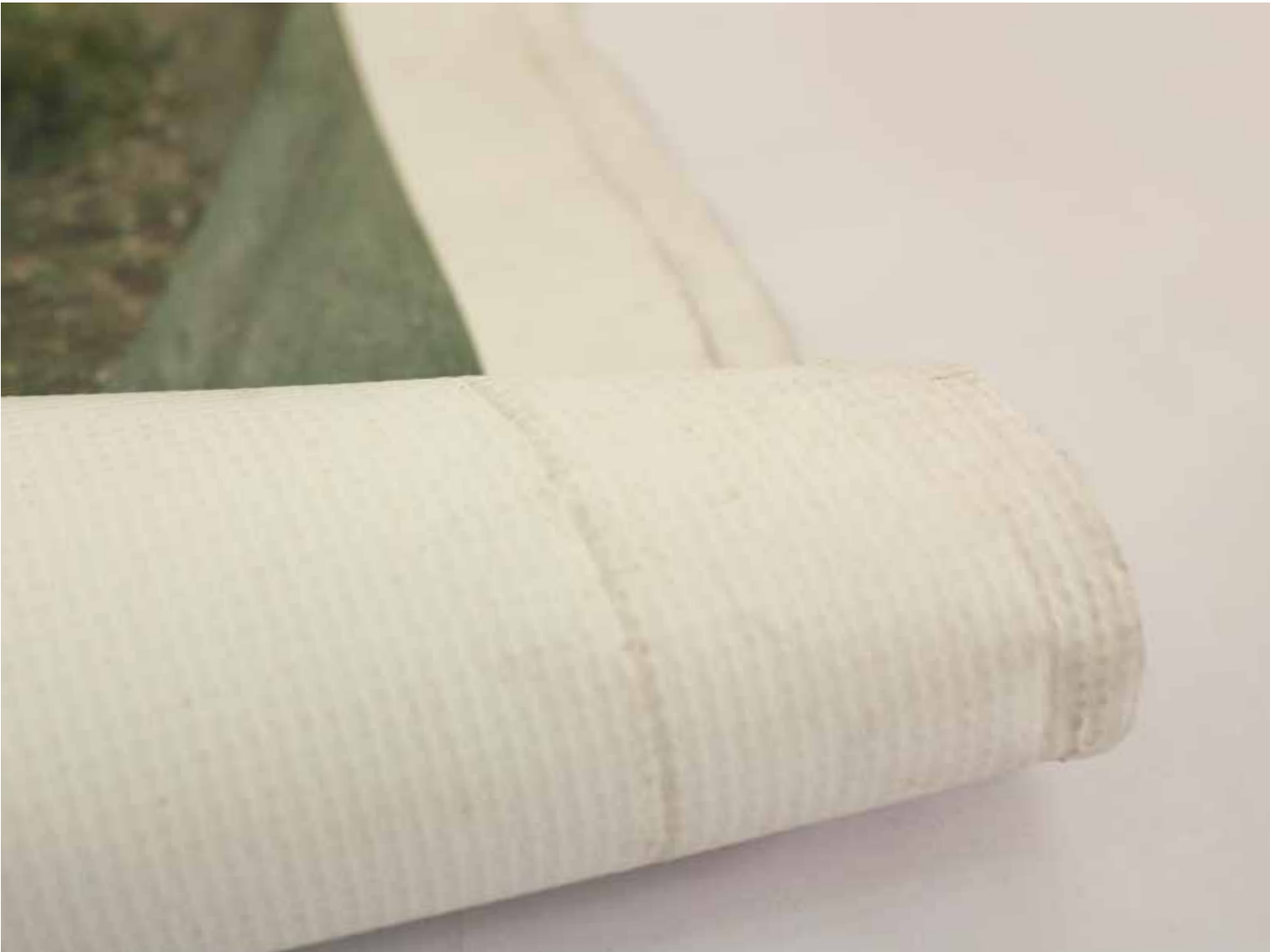
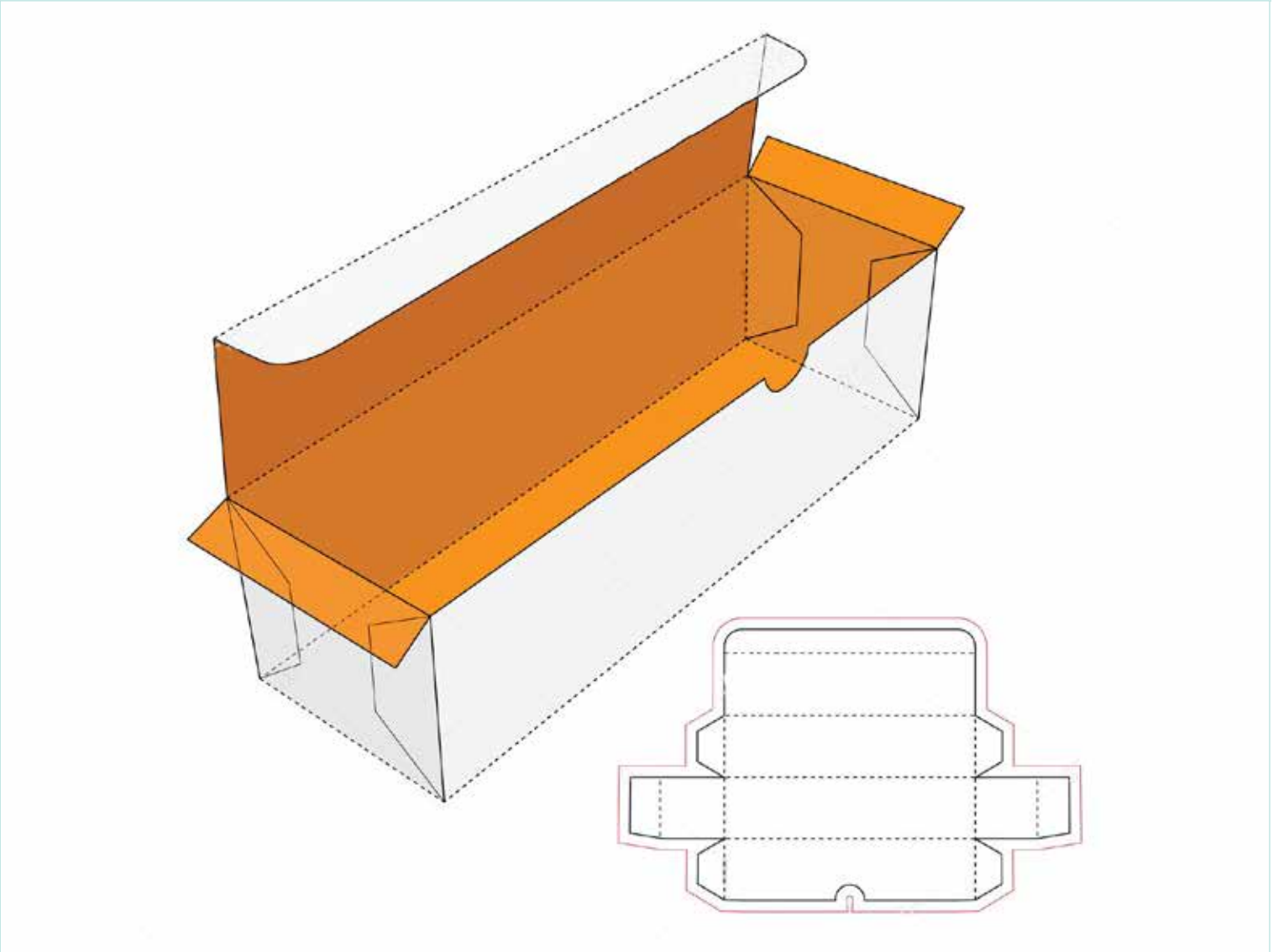

Materials to be used for the case:
-recycled PVC Vinyl
(from billboards)

Magnets for the closing mechanism

FIRST SKETCHES

Inspired in cardboard boxes:
how they transform from a
two dimensional piece, to a
tridimensional one I draw different
boxes/cases

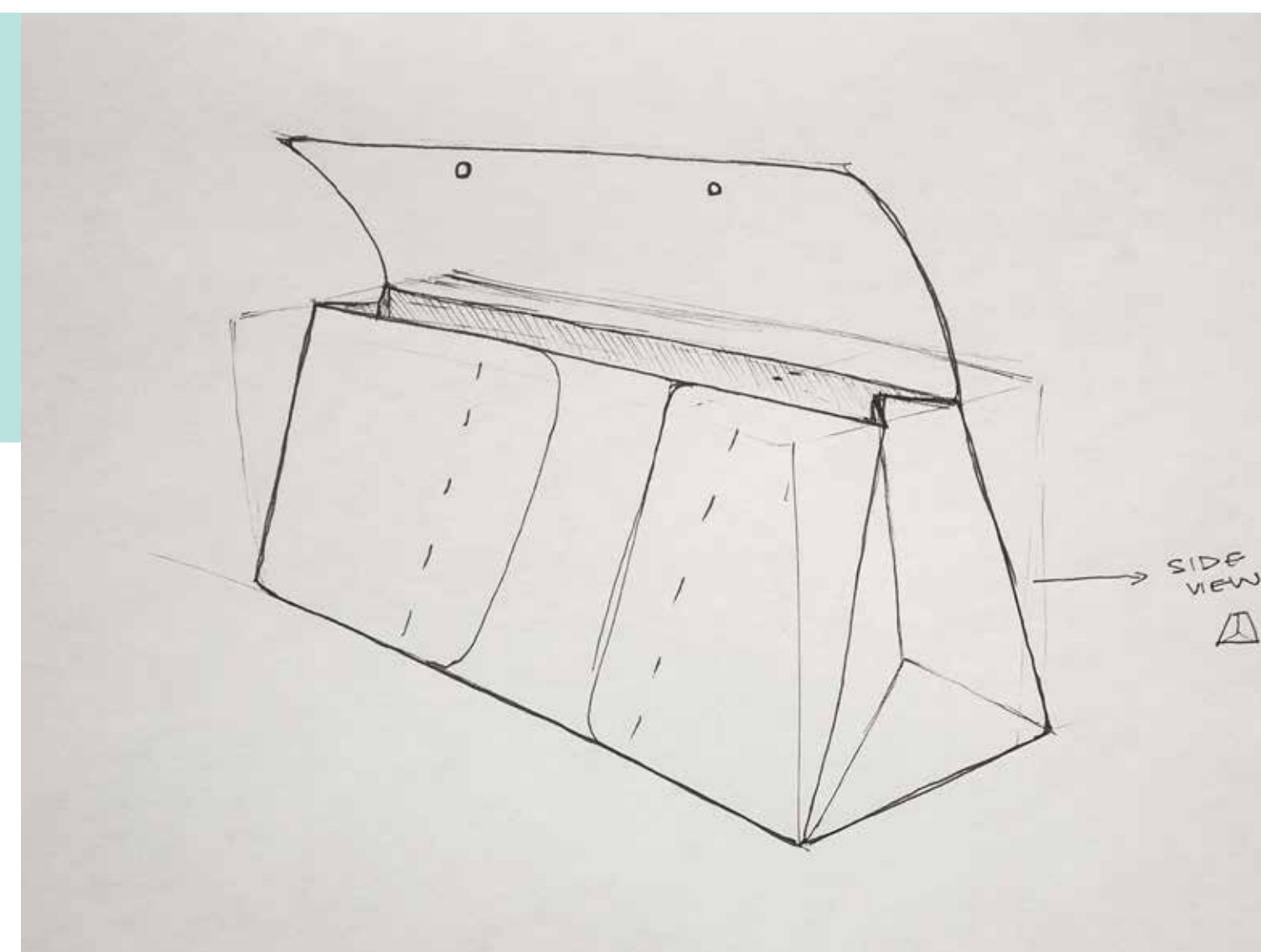
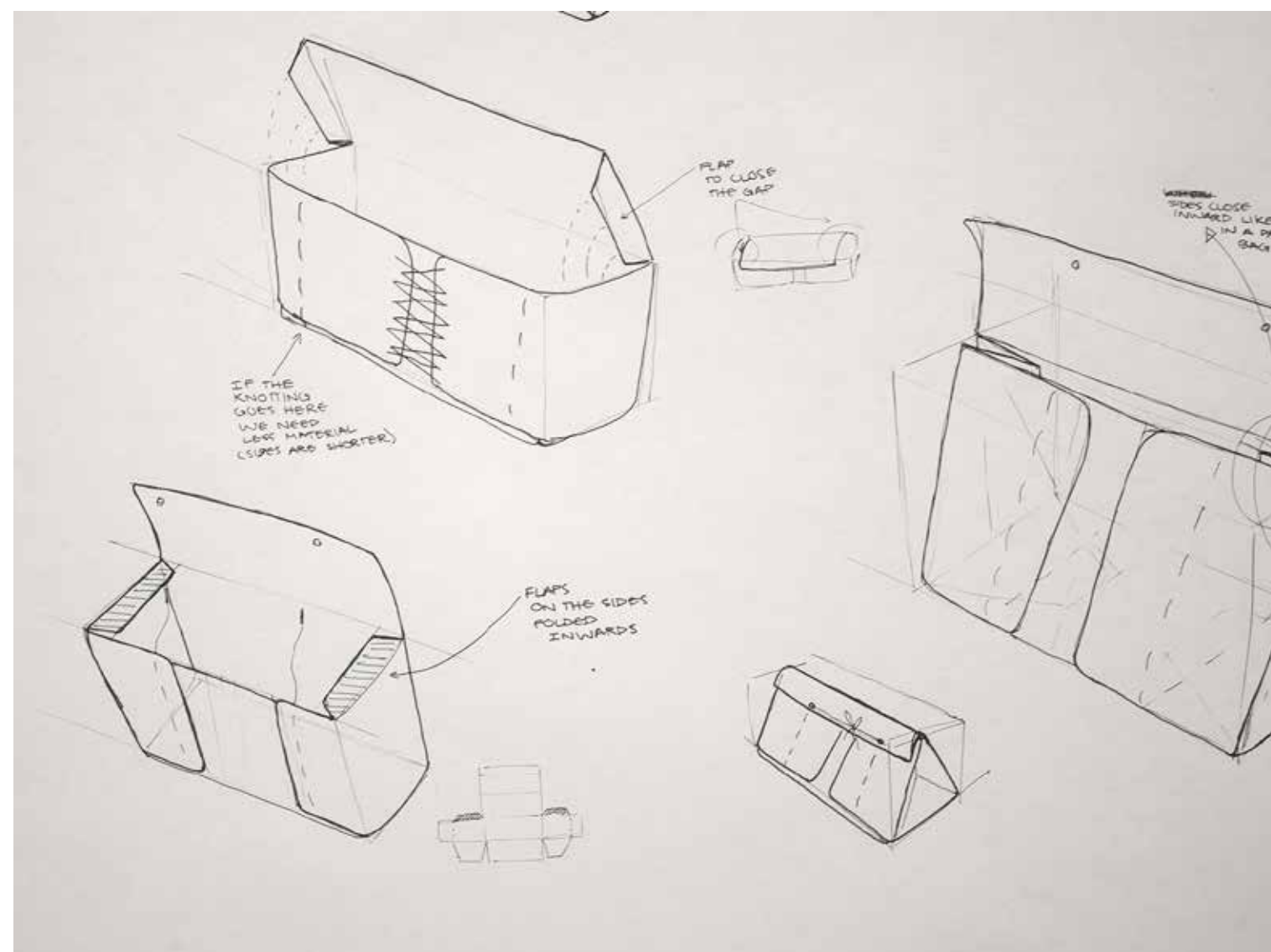
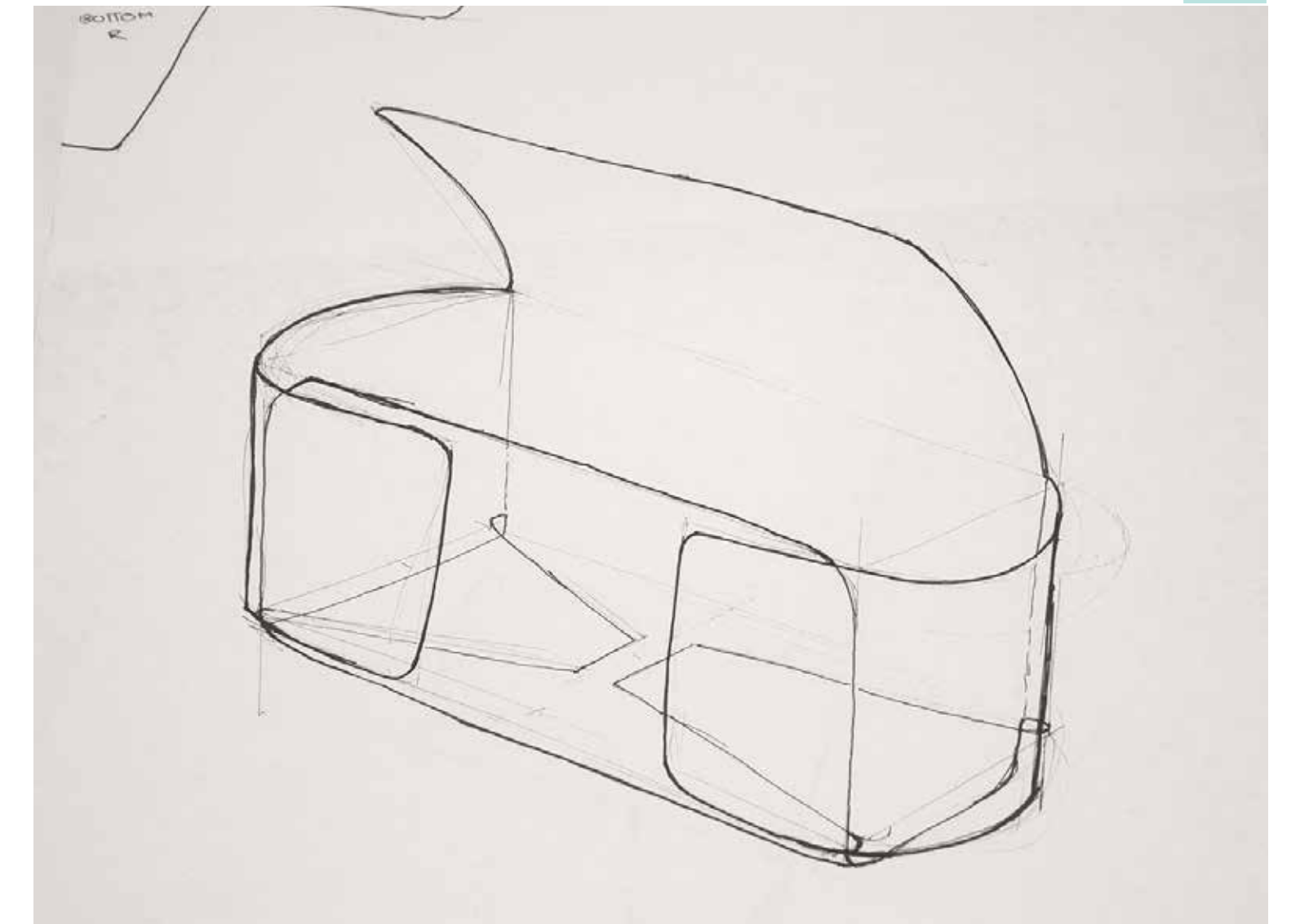
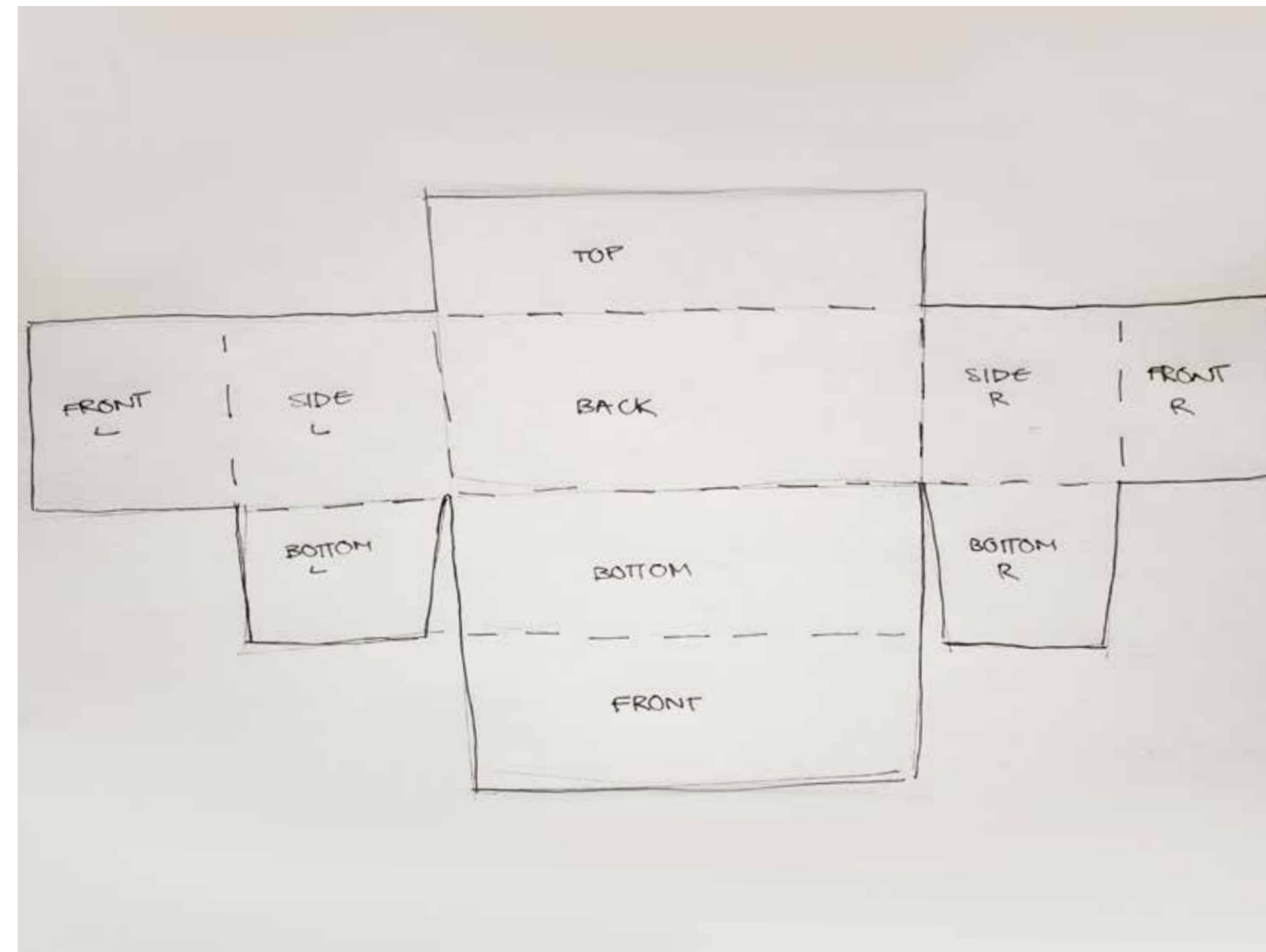

CLOSING OPTIONS

Exploring closing mechanisms;
First I went for a closing
system with shoe laces

FINAL MECHANISM

After prototyping, I found out that the shoe lace mechanism was too complex, so I went for an easier to use design with magnets

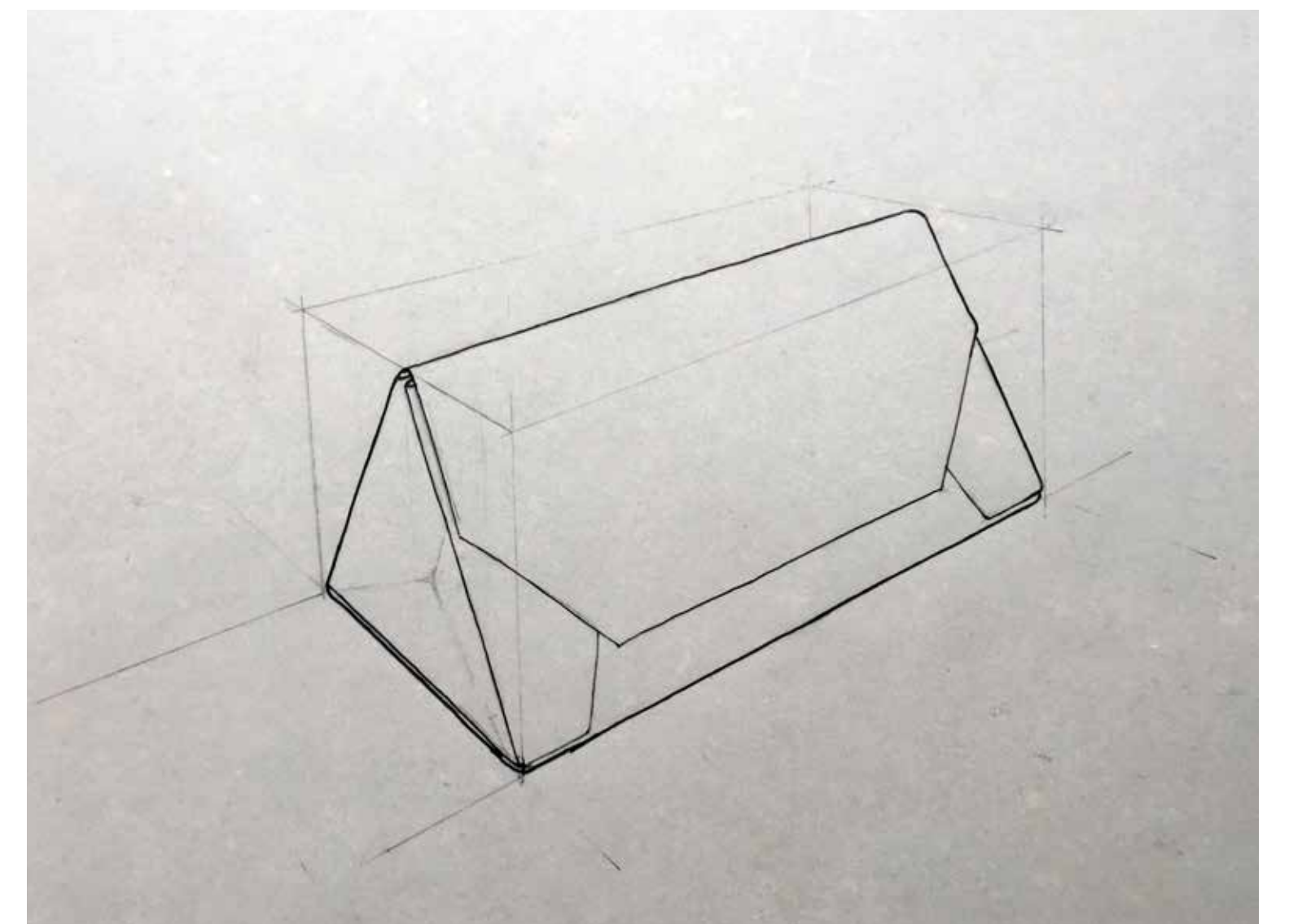
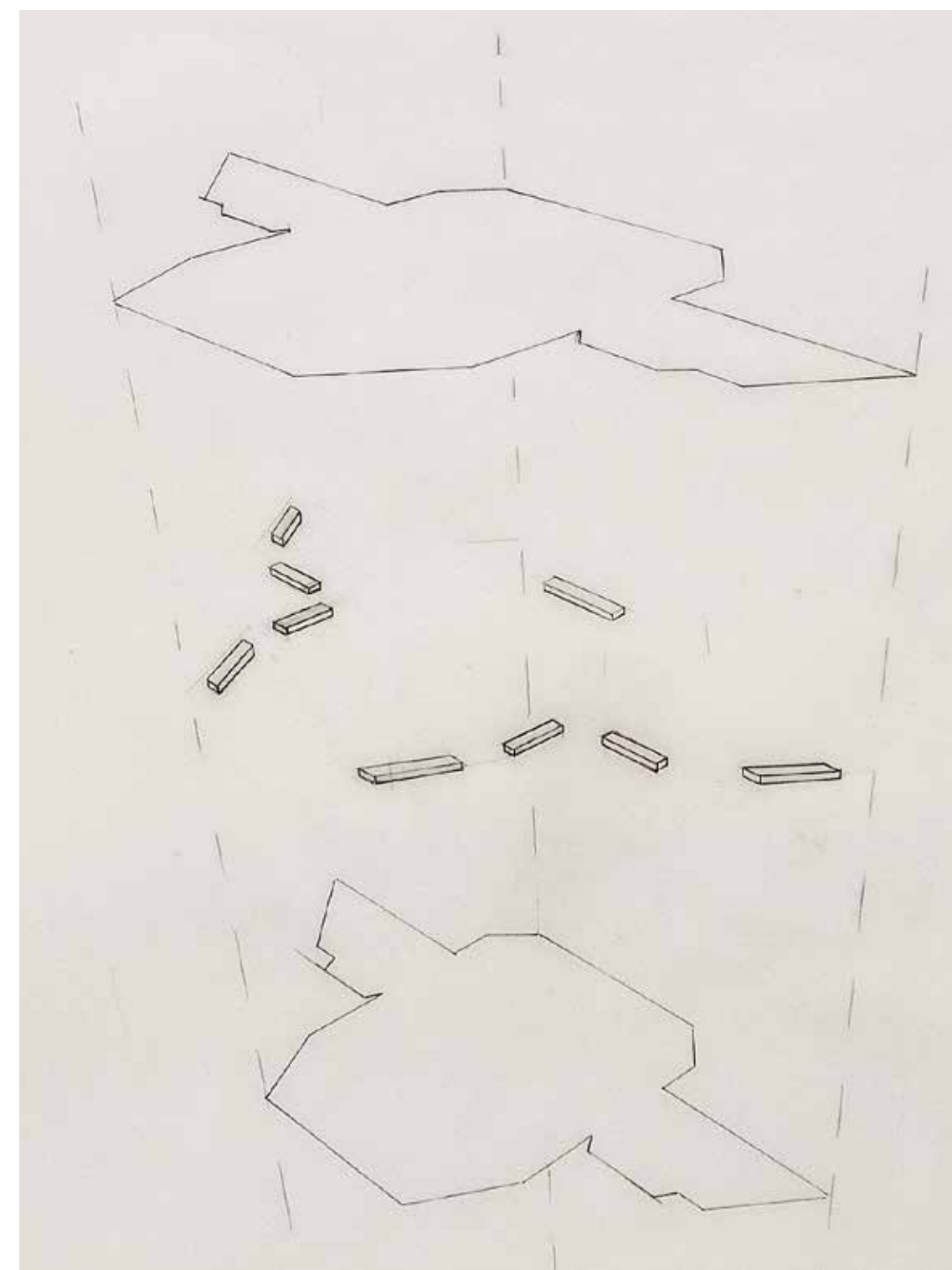
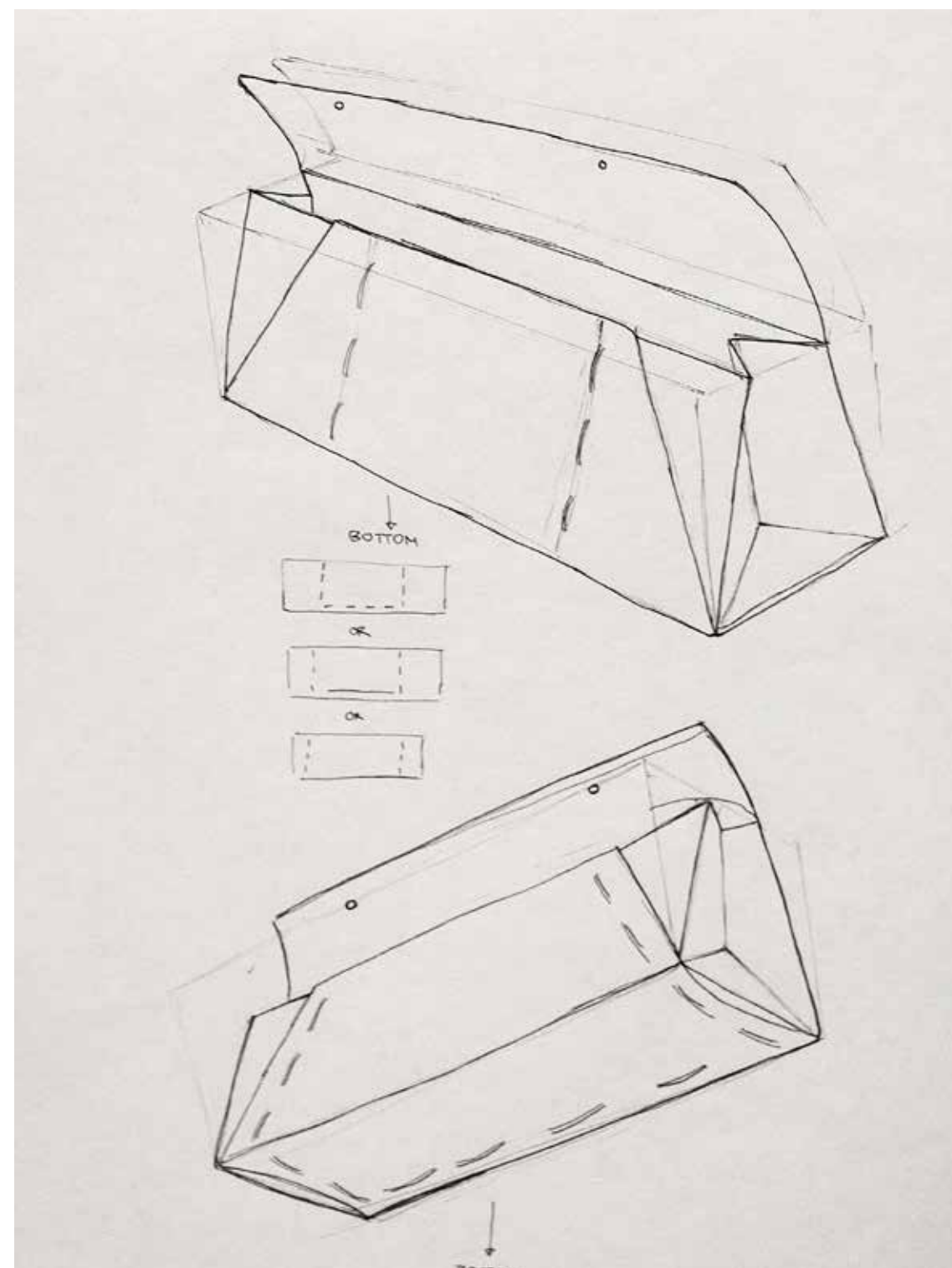

ASSEMBLY OF THE CASE

Example of how the case is put together using the magnet mechanism

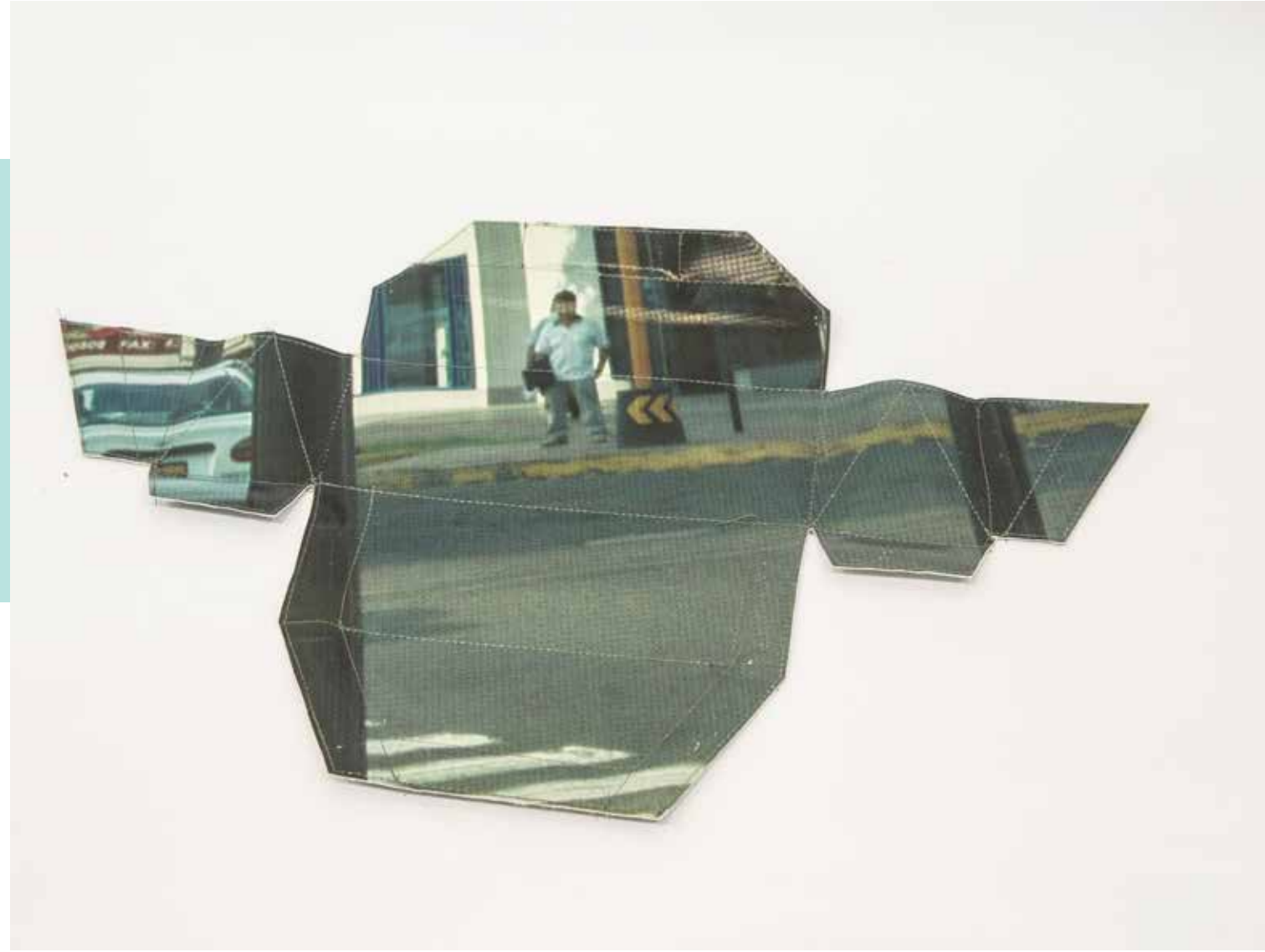

FINAL PRODUCT





PROJECT SUMMARY

I was commissioned to design a kitchen cabinet for a beach house that fulfilled three functions: have a dining table, include storage for two water drums, and have a place for a wine cooler. When I designed this project, I paid close attention to both the aesthetic and the practical needs of the customer.

DESIGN PROCESS

I sketched several possibilities for the cabinet, and then the customer chose the one he liked the most. Then I drew up the blueprints for it, and a carpenter crafted it.

September 2019

BACKGROUND RESEARCH

Mesuring the objects that would be stored in the cabinet:

- Wine fridge
- Water Ddrum

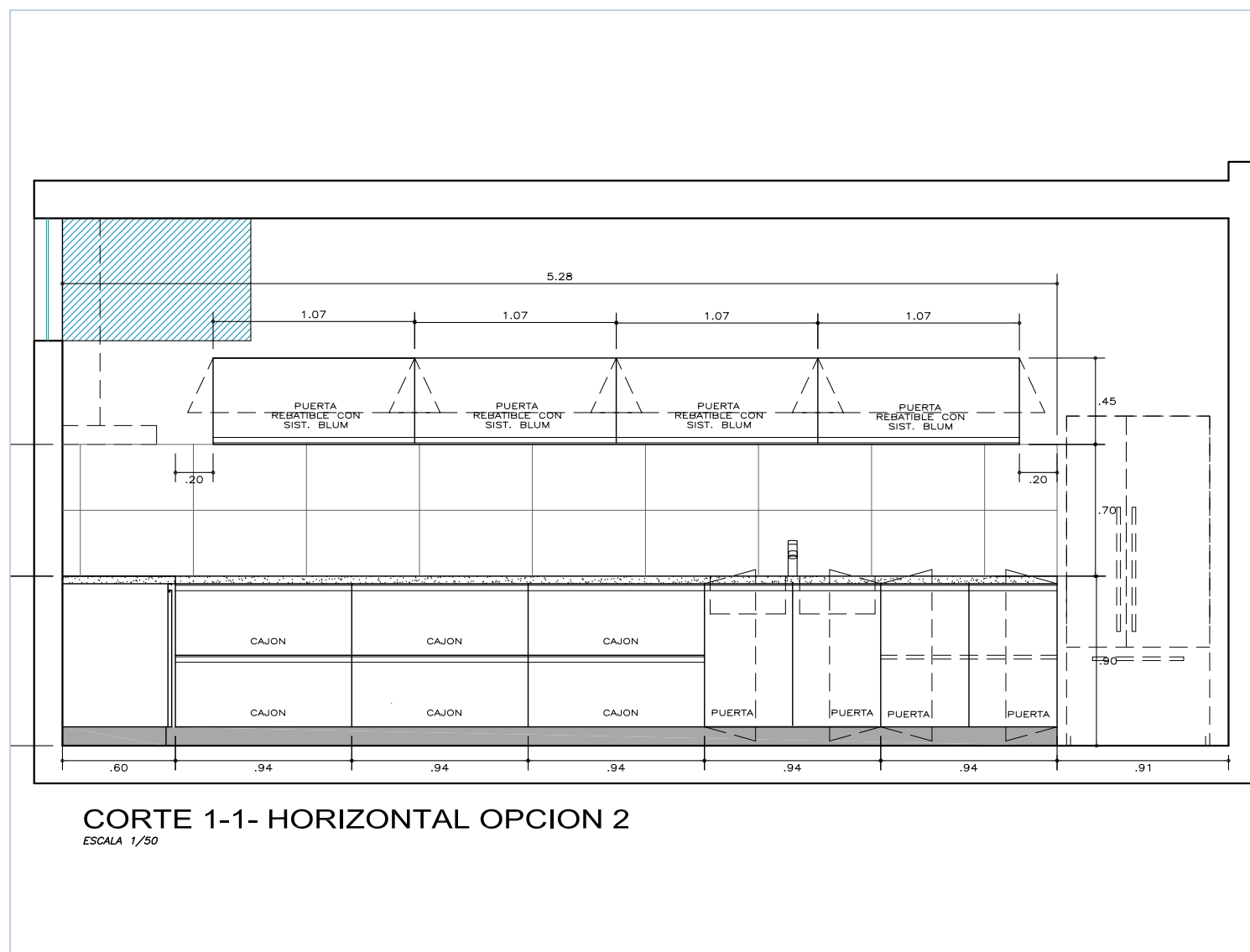
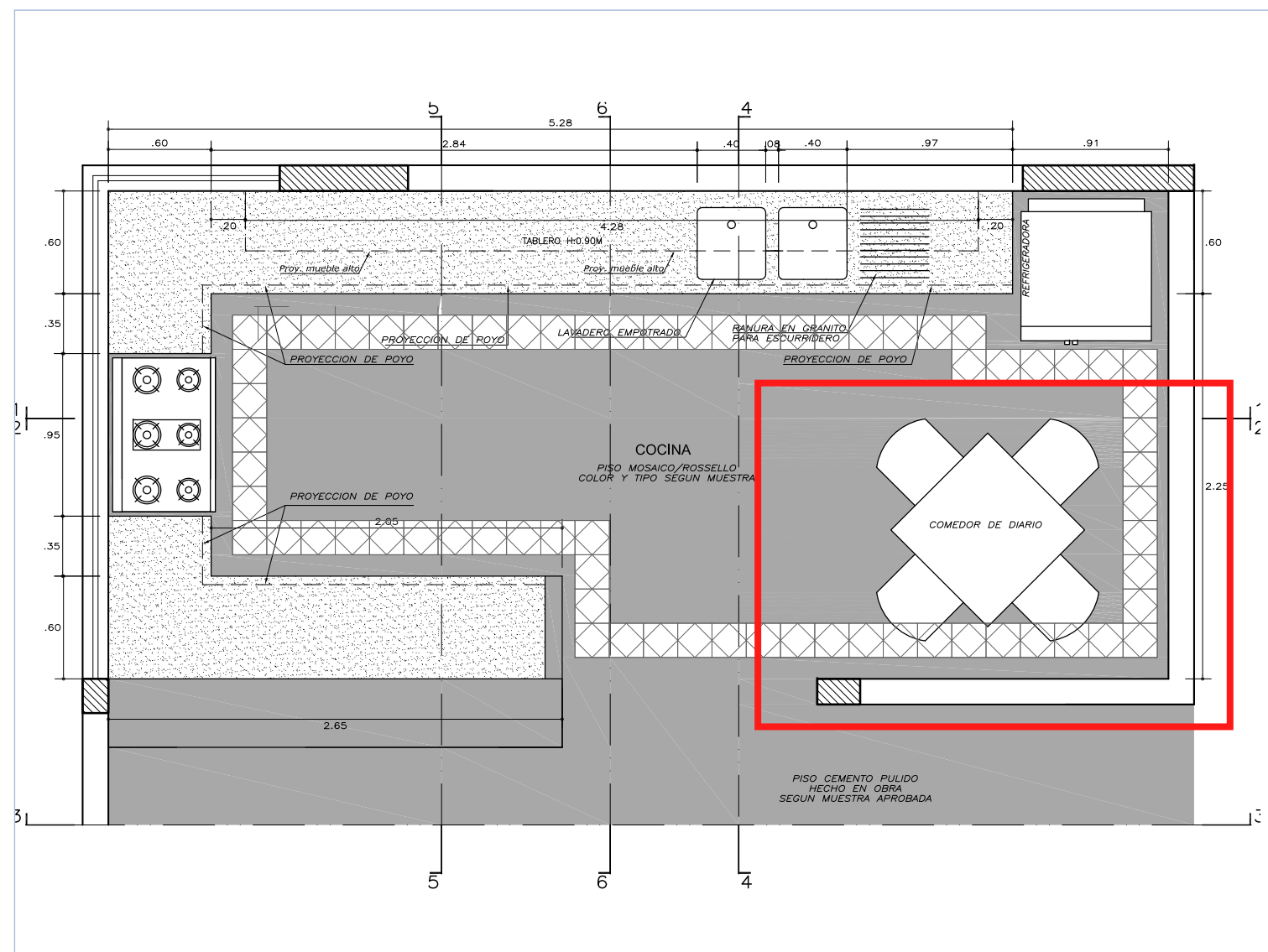
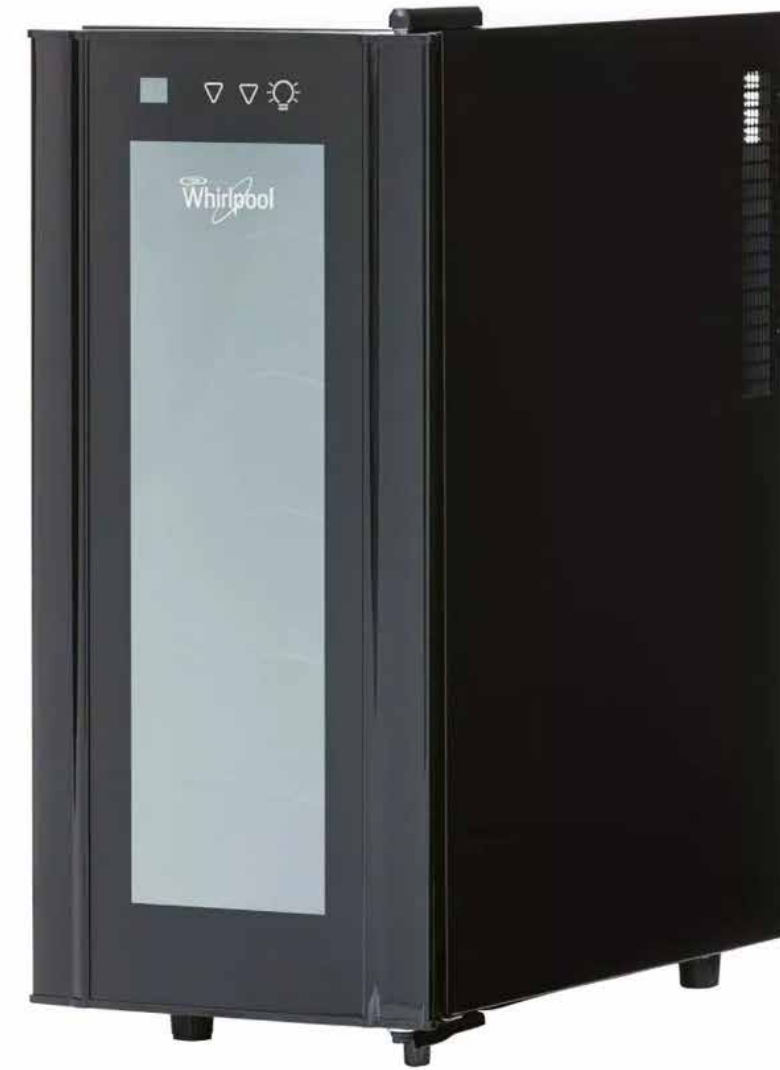

Using the blueprints of the house to dimension the cabinet and make it follow the proportions and aesthetic of the rest of the kitchen as much as possible

IDEATING

Different set ups of the cabinet

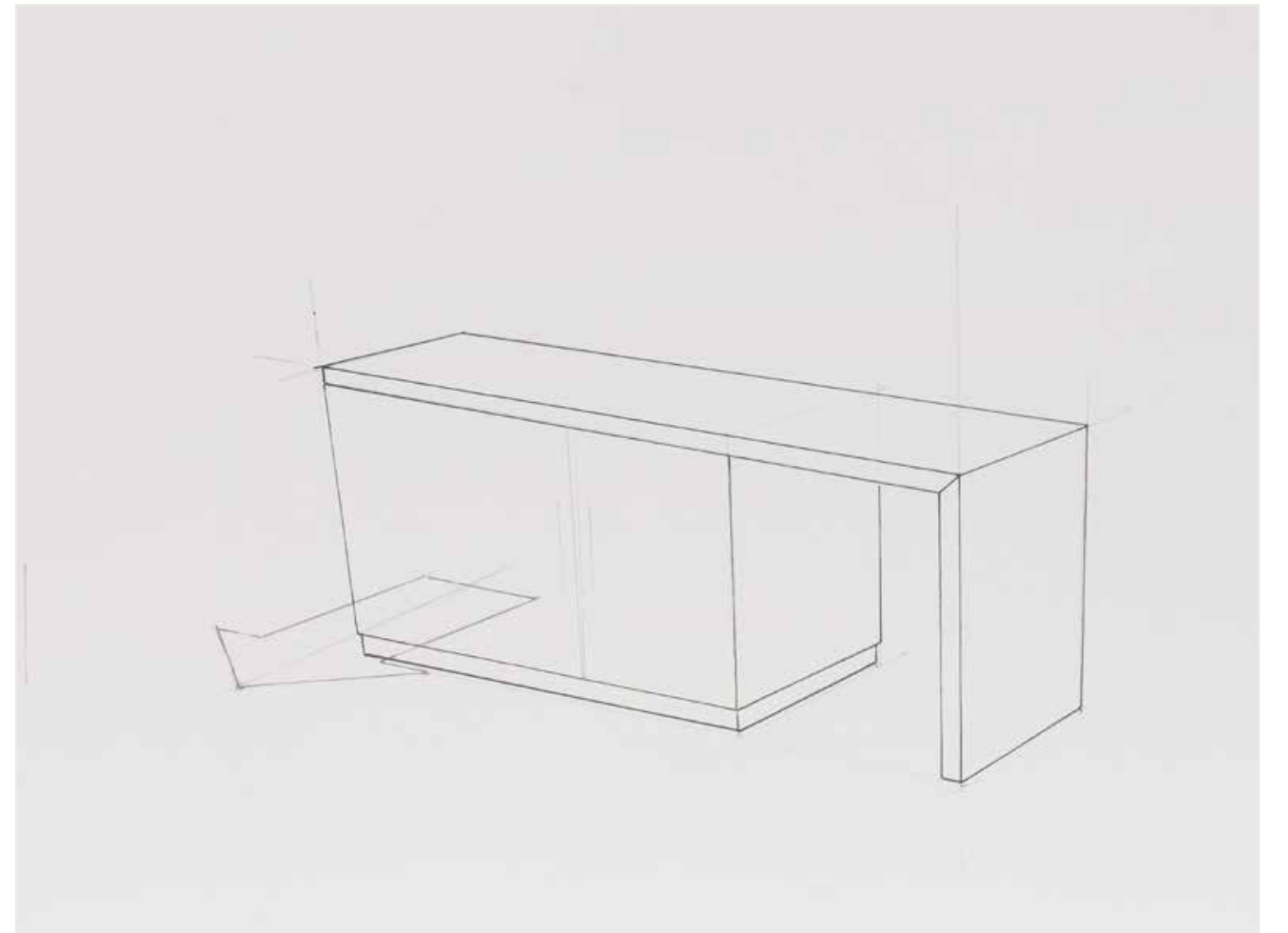
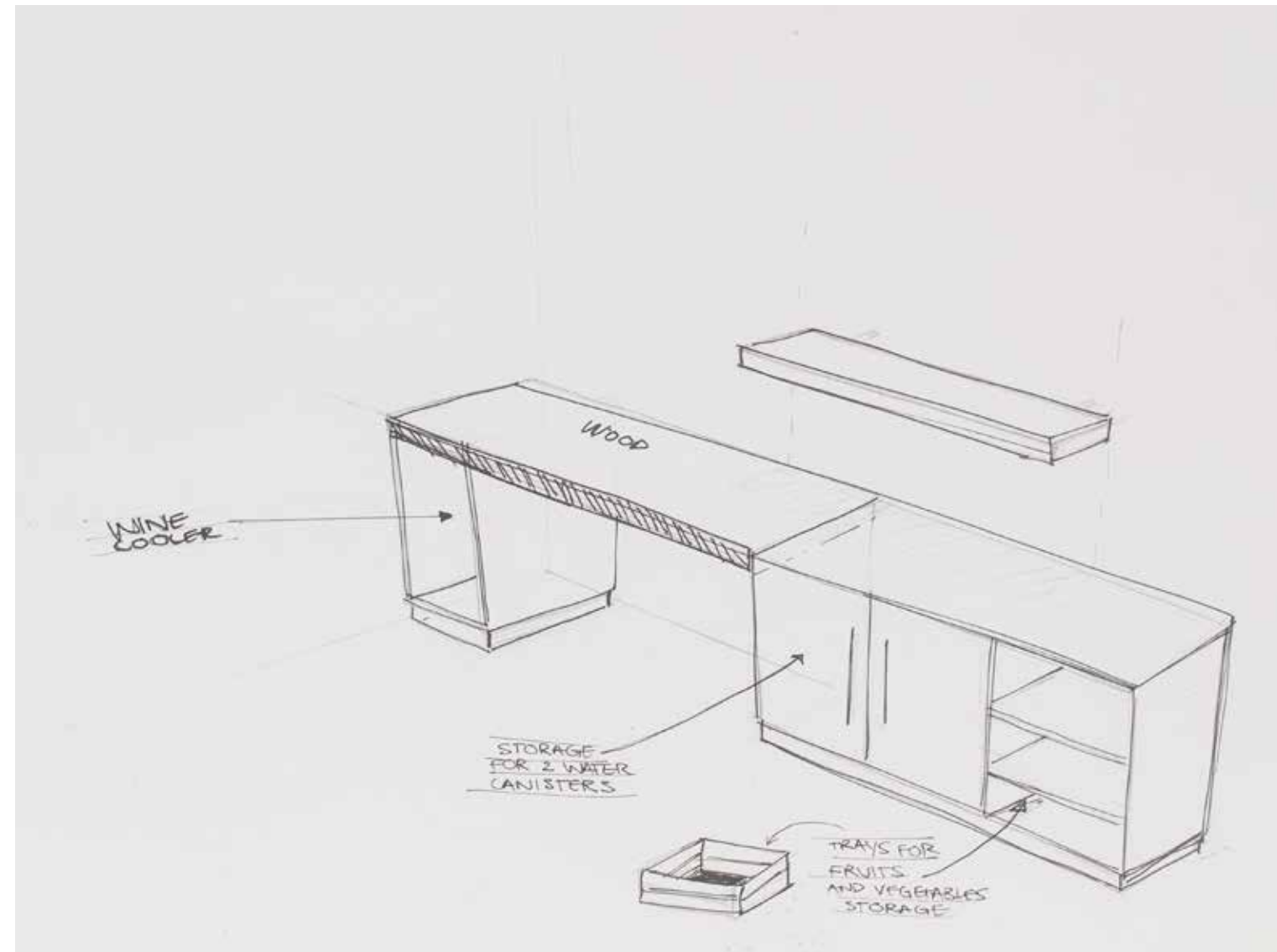
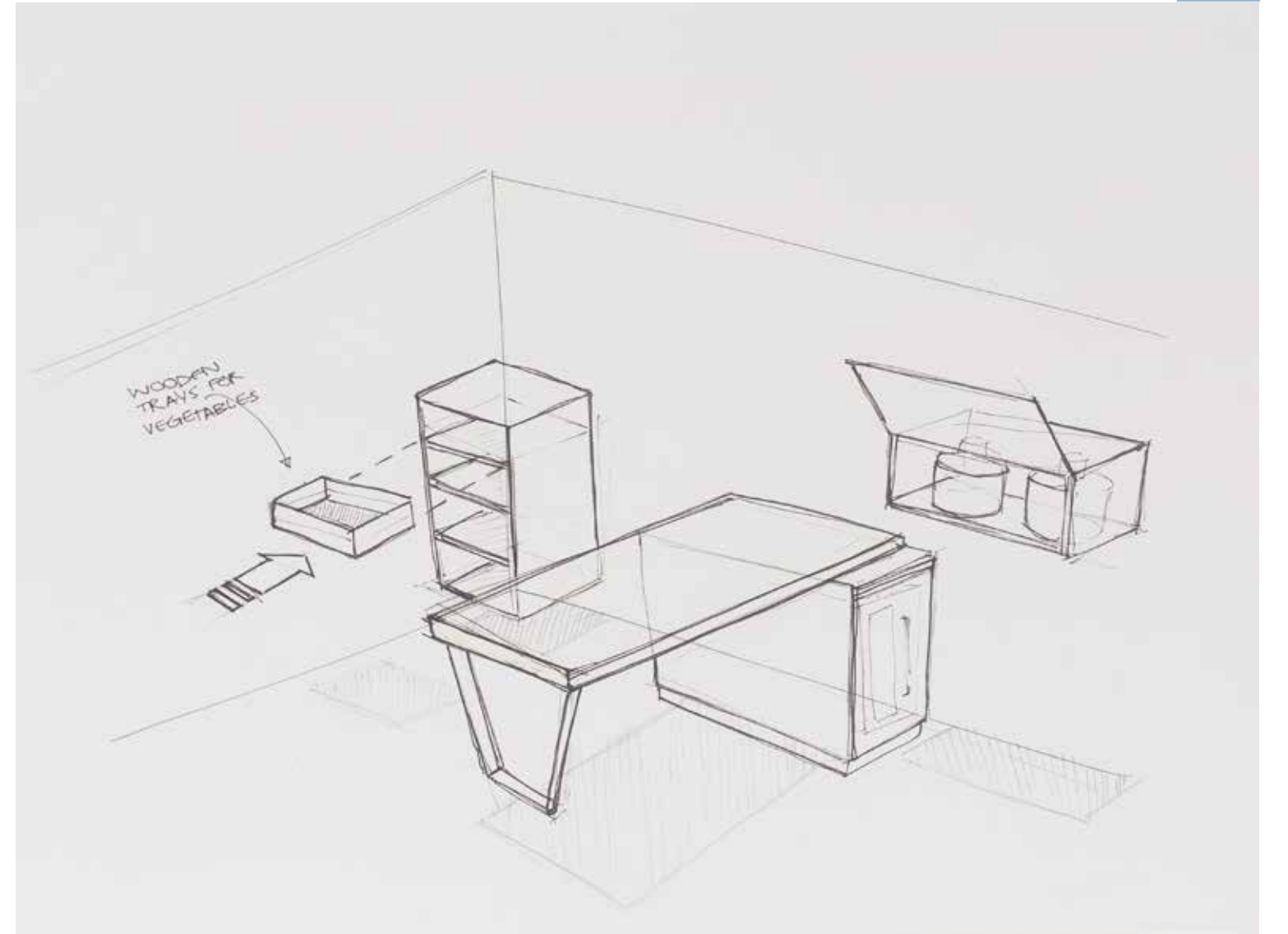
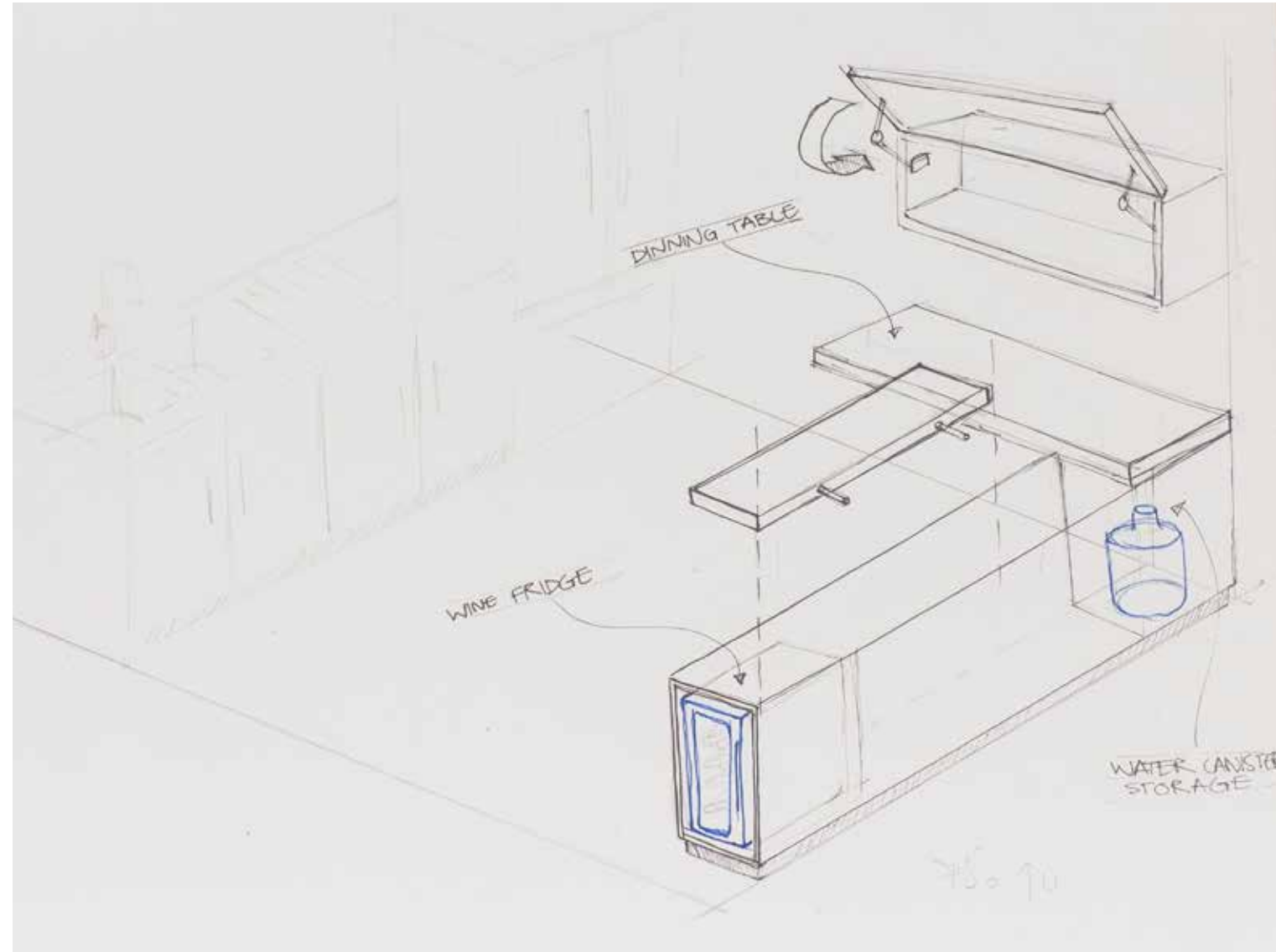

REFINING SHAPE AND MATERIALS

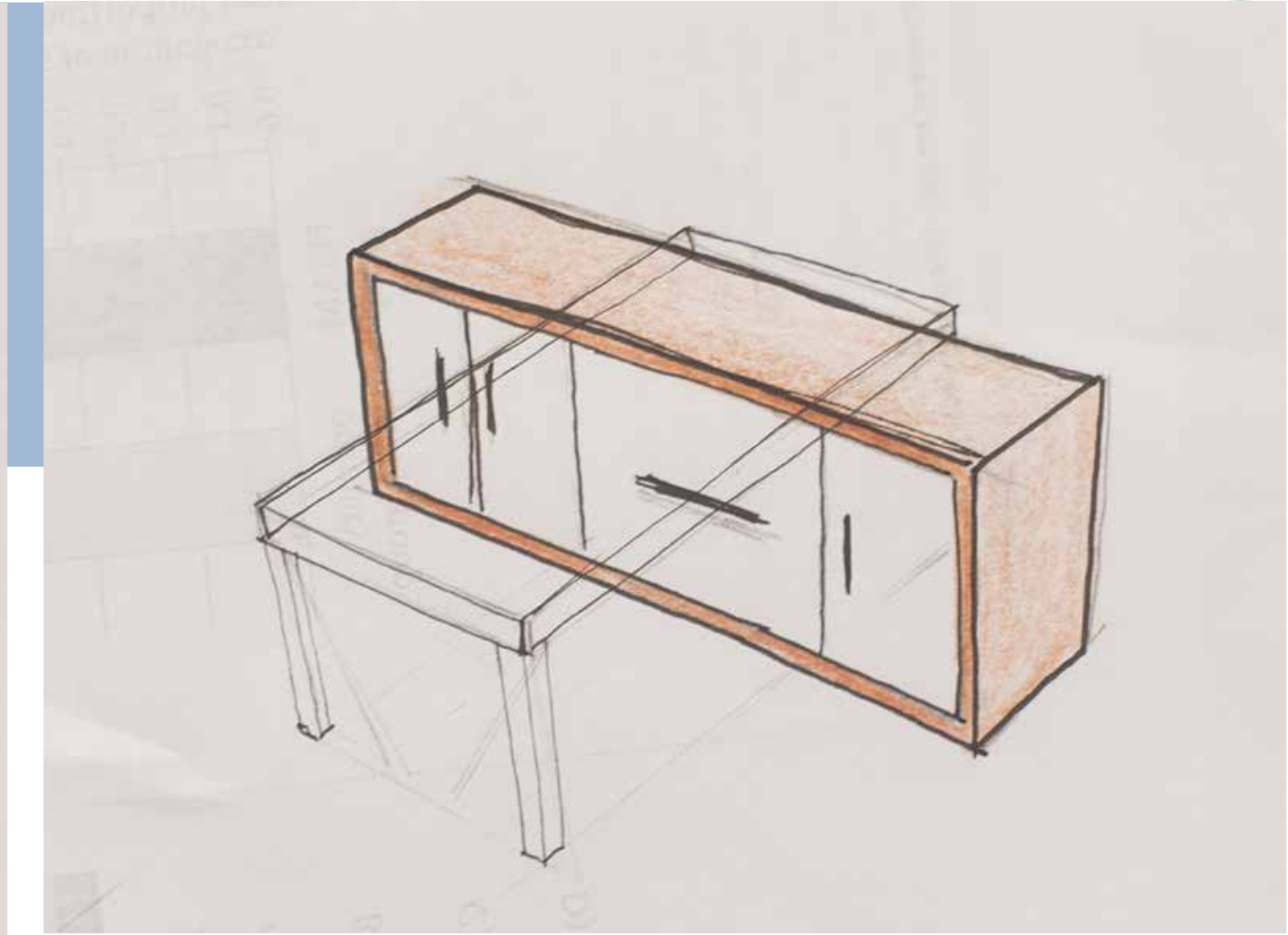
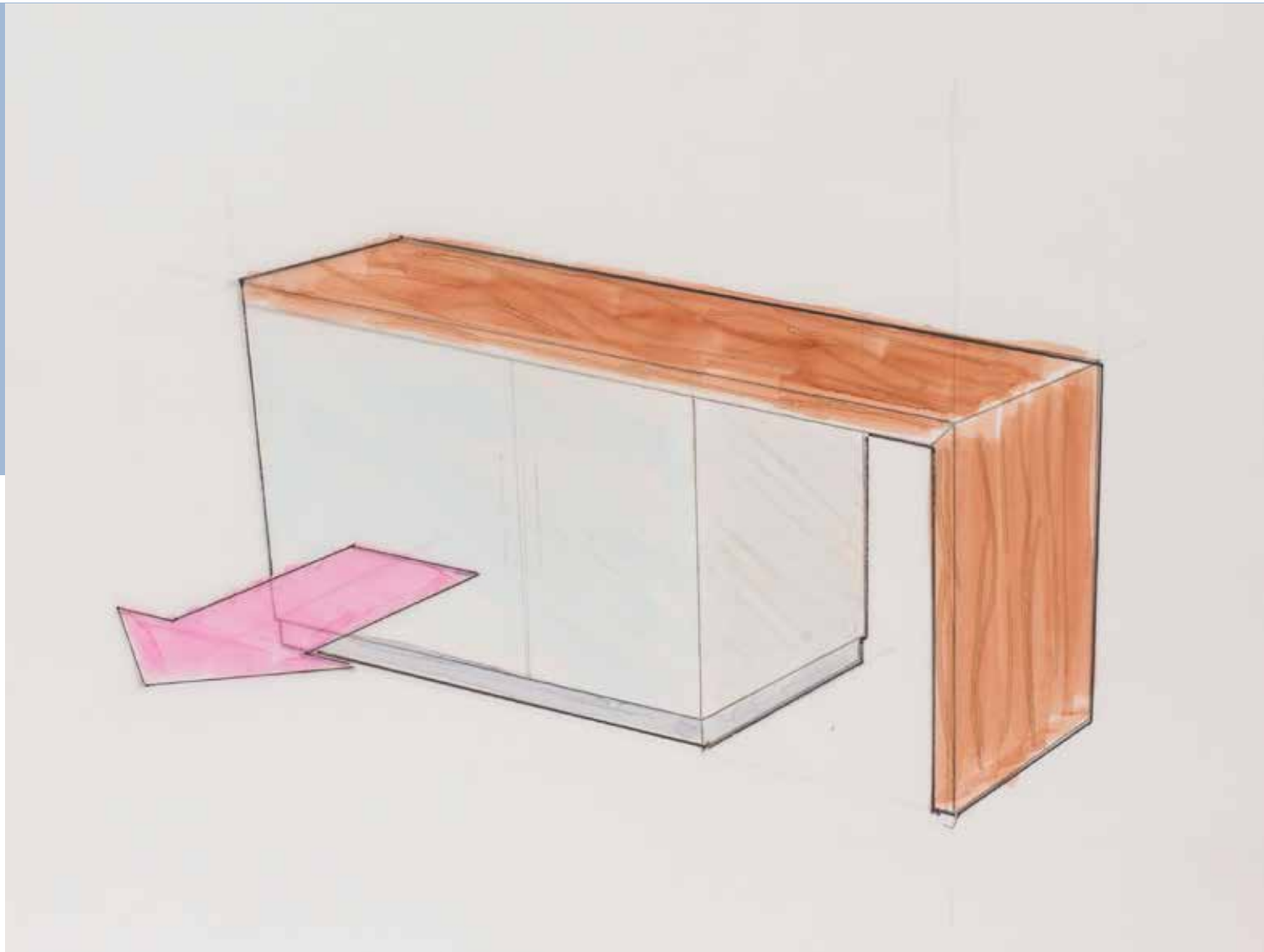

DEFINING TABLE SIZE

WINE FRIDGE DRAWER

Exploring different mechanism for storing th wine fridge.
The left down sketch is the final design

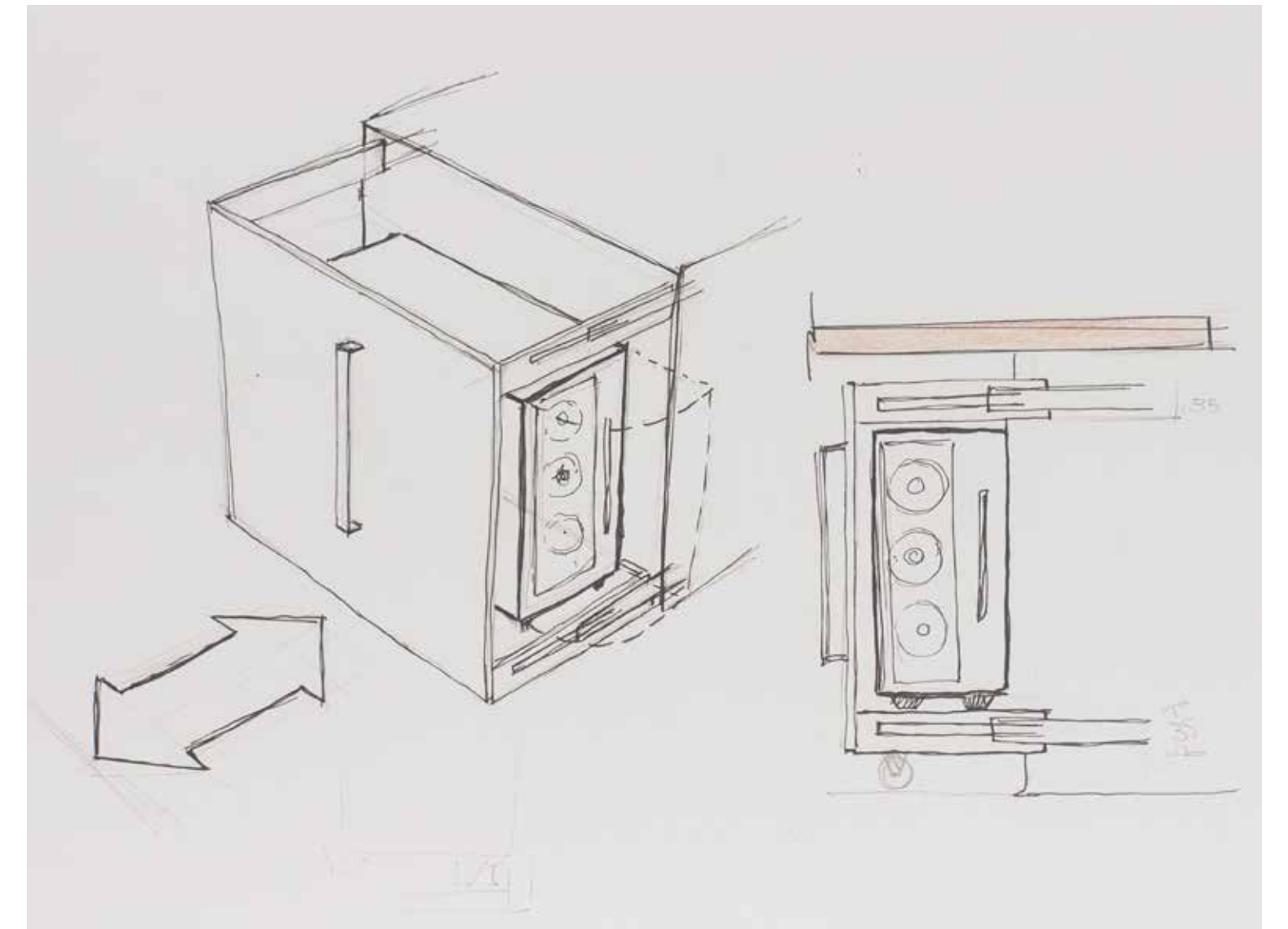
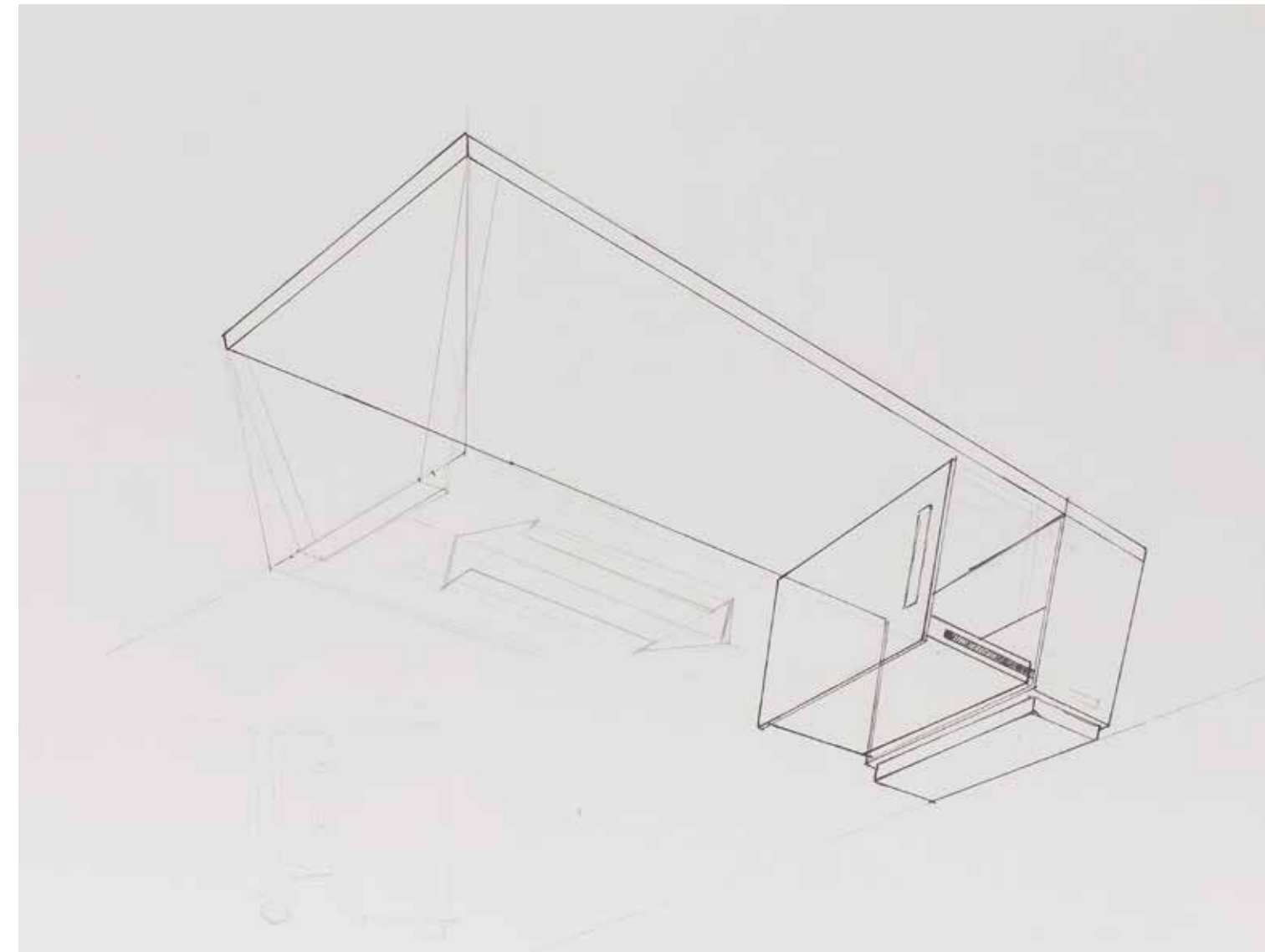
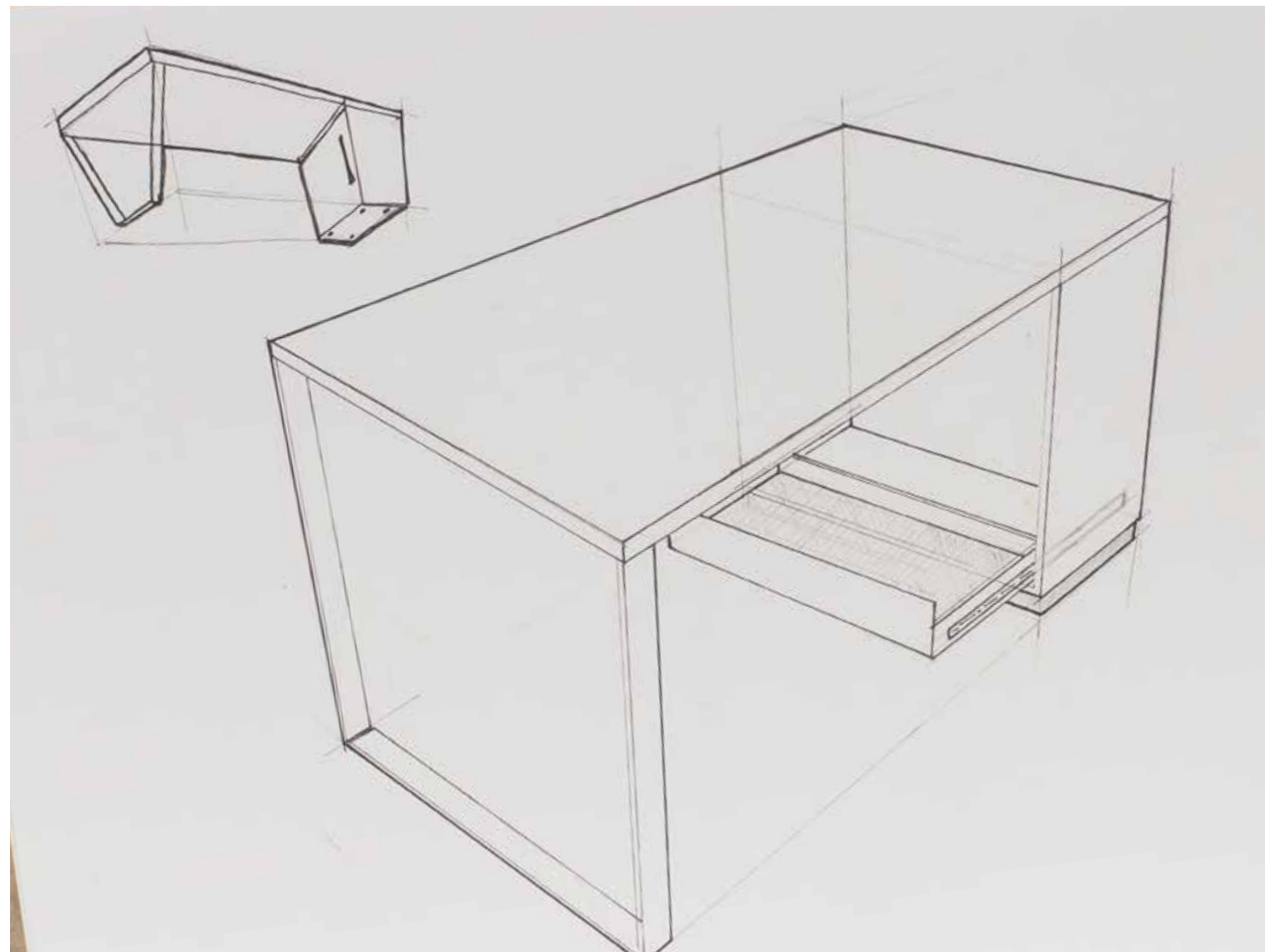
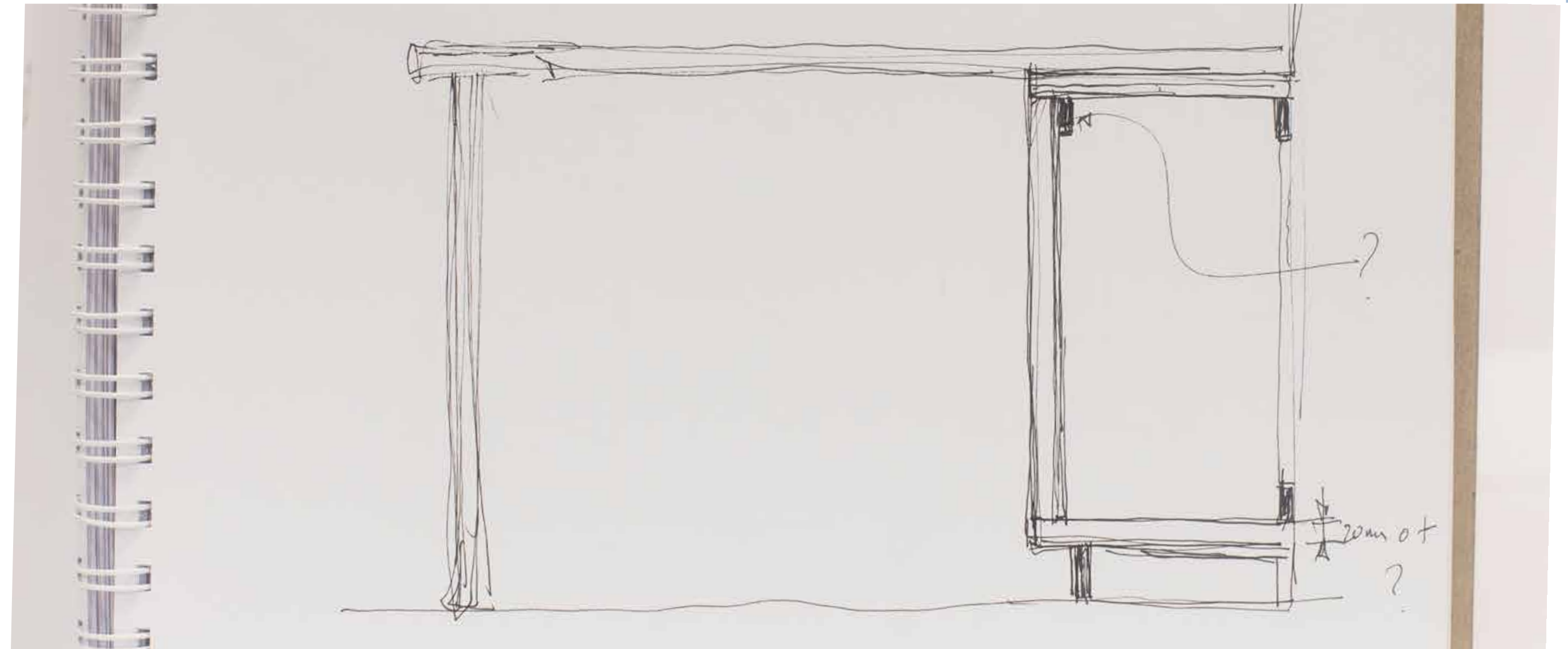

DETAILS (CLOSEUPS)

- Front view of the cabinet
- Water drums storage
- Cross sectional blueprint of the wine fridge drawe
- Finished wine fridge drawe

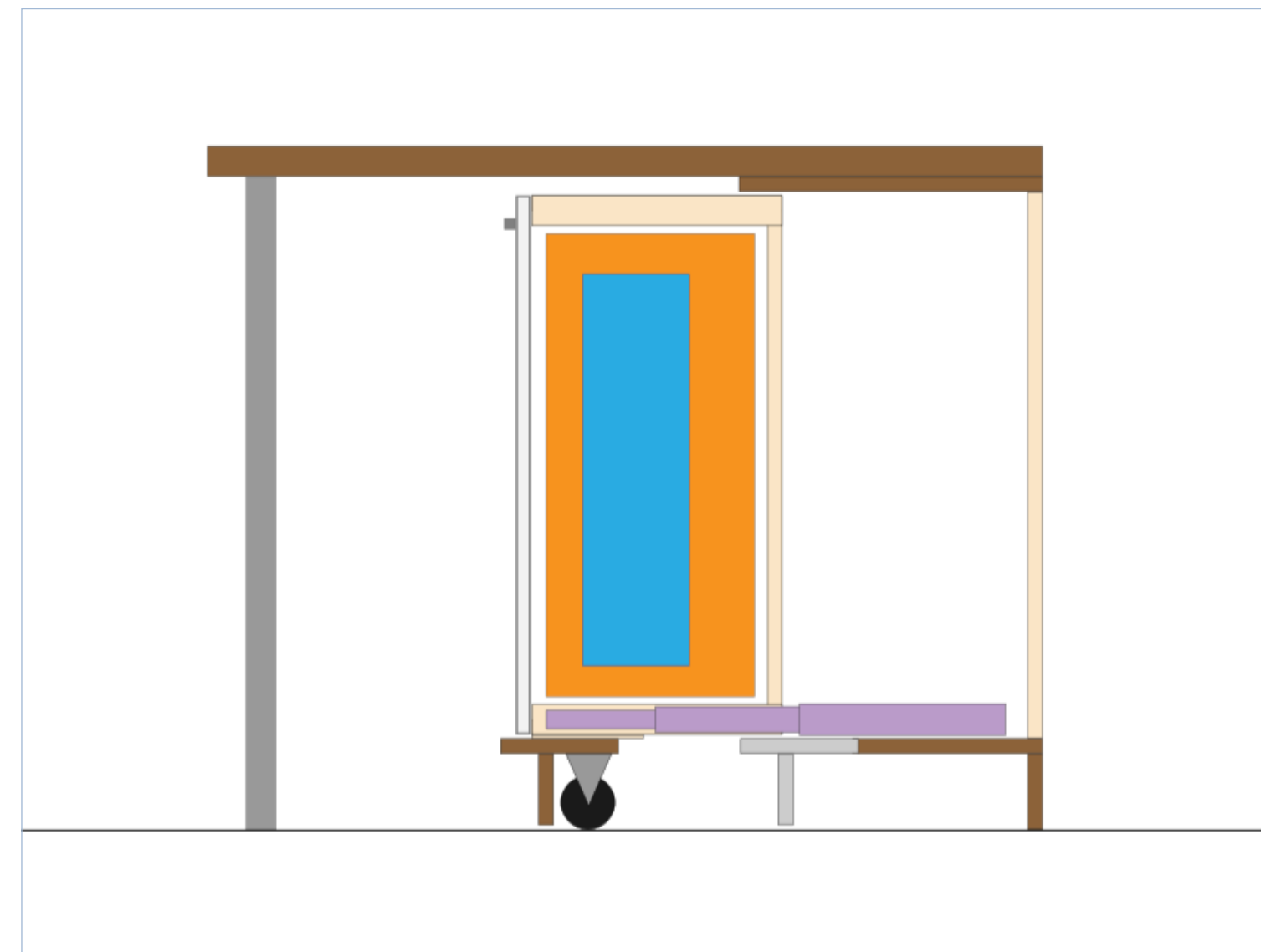
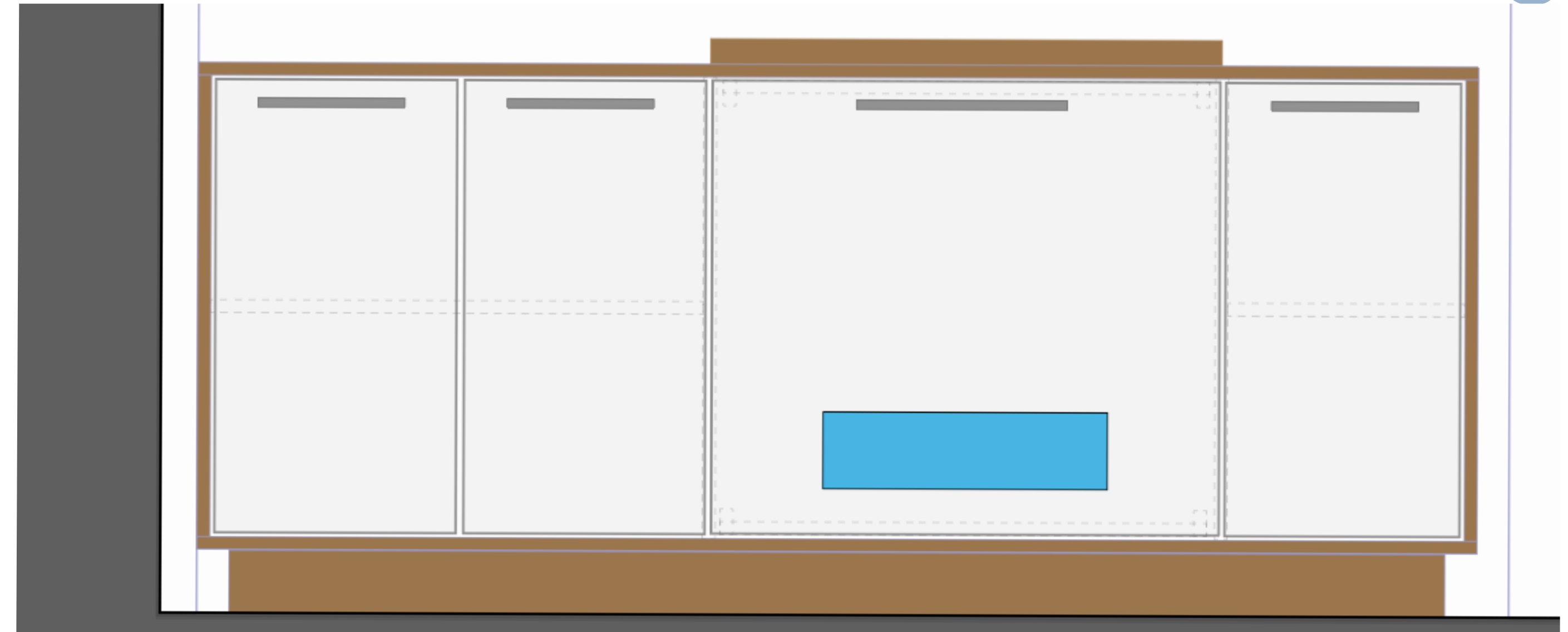

FINAL PRODUCT



THANK YOU

I look forward to hearing from you